

**SOLE**<sup>™</sup>  
FITNESS

**OWNER'S MANUAL**  
**Model: 16208983520**

*Please carefully read this entire manual  
before operating your new bike.*

**ATTENTION:** Before returning your Sole product to any retailer, or if you require any assistance with assembly or technical support please call us first for assistance at 1-888-707-1880. Thank you for your Sole purchase.

# TABLE OF CONTENTS

<u>Product Registration</u>	<b>3</b>
<u>Important Safety Instructions</u>	<b>4</b>
<u>Important Electrical Instructions</u>	<b>5</b>
<u>Important Operation Instructions</u>	<b>5</b>
<u>Assembly Instructions</u>	<b>8</b>
<u>Operation of Your New Fitness Bike</u>	<b>12</b>
<u>Using Heart Rate Monitor</u>	<b>26</b>
<u>Exploded View Diagram</u>	<b>27</b>
<u>Parts List</u>	<b>28</b>
<u>Manufacturer's limited warranty</u>	<b>31</b>

**ATTENTION**

THIS FITNESS BIKE IS INTENDED FOR RESIDENTIAL USE ONLY AND IS WARRANTED FOR THE APPLICATION. ANY OTHER APPLICATION VOIDS THIS WARRANTY IN ITS ENTIRETY.



# SOLE

## FITNESS

CONGRATULATIONS ON YOUR NEW RECUMBENT, AND WELCOME TO THE SOLE FAMILY!

Thank you for your purchase of this quality Sole recumbent from Dyaco Canada Inc. Your new recumbent has been manufactured by one of the leading fitness manufacturers in the world and is backed by one of the most comprehensive warranties available. Dyaco Canada Inc. will do all we can to make your ownership experience as pleasant as possible for many years to come.

If you have any questions about your new Sole product or questions about the warranty, contact Dyaco Canada Inc. at 1-888-707-1880.

Please take a moment at this time to record below the name of the dealer, their telephone number, and the date of purchase for easy contact in the future. We appreciate your confidence in SOLE, and we will always remember that you are the reason that we are in business. Please go to [www.dyaco.ca/warranty.html](http://www.dyaco.ca/warranty.html) and complete the online warranty registration.

Yours in Health,  
Dyaco Canada Inc.

Name of Dealer \_\_\_\_\_

Telephone Number of Dealer \_\_\_\_\_

Purchase Date \_\_\_\_\_

## PRODUCT REGISTRATION

### RECORD YOUR SERIAL NUMBER

Please record the Serial Number of this fitness product in the space provided below.

Serial Number \_\_\_\_\_

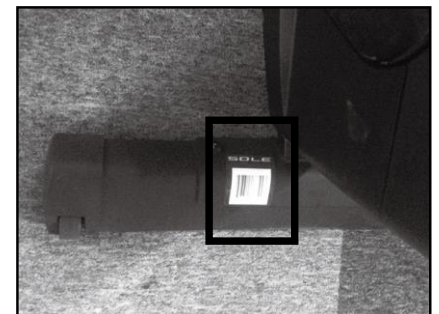

# IMPORTANT SAFETY INSTRUCTIONS

**WARNING** - Read all instructions before using this equipment.

- Do not operate fitness bike on deeply padded, plush or shag carpet. Damage to both carpet and fitness bike may result.
- Keep children away from the fitness bike. There are obvious pinch points and other caution areas that can cause harm.
- Keep hands away from all moving parts.
- Never operate the fitness bike if it has a damaged cord or plug. If the fitness bike is not working properly, call your dealer.
- Keep the cord away from heated surfaces.
- Never drop or insert any object into any openings.
- Do not use outdoors.
- Do not attempt to use your fitness bike for any purpose other than for the purpose it is intended.
- The hand pulse sensors are not medical devices. Various factors, including the user's movement, may affect the accuracy of heart rate readings. The pulse sensors are intended only as exercise aids in determining heart rate trends in general.
- Wear proper shoes. High heels, dress shoes, sandals or bare feet are not suitable for use on your fitness bike. Quality athletic shoes are recommended to avoid leg fatigue or injury.
- This equipment is not intended for use by persons with reduced physical, sensory or mental capabilities or lack of experience and knowledge unless they have been given supervision or instruction concerning use of the equipment by a person responsible for their safety.

**SAVE THESE INSTRUCTIONS - THINK SAFETY!**

# IMPORTANT ELECTRICAL INSTRUCTIONS

## WARNING!

**NEVER** remove any cover without first disconnecting AC power.

If voltage varies by ten percent (10%) or more, the performance of your fitness bike may be affected.

**Such conditions are not covered under your warranty.** If you suspect the voltage is low, contact your local power company or a licensed electrician for proper testing.

**NEVER** expose this fitness bike to rain or moisture. This product is **NOT** designed for use outdoors, near a pool or spa, or in any other high humidity environment. The operating temperature specification is 40 to 120 degrees Fahrenheit, and humidity is 95% non-condensing (no water drops forming on surfaces).

# IMPORTANT OPERATION INSTRUCTIONS

**NEVER** operate this fitness bike without reading and completely understanding the results of any operational change you request from the computer.

**NEVER** use your fitness bike during an electrical storm. Surges may occur in your household power supply that could damage fitness bike components. Unplug the fitness bike during an electrical storm as a precaution.

Do not use excessive pressure on console control keys. They are precision set to function properly with little finger pressure. If you feel the buttons are not functioning properly with normal pressure, contact your **SOLE** dealer.

# TRANSPORT INSTRUCTIONS

The fitness bike is equipped with two transport wheels which are engaged when the rear of the fitness bike is lifted.

# ASSEMBLY PACK CHECKLIST

Note: The hardware could be found on the cycle or found in the hardware bag for each step.

## 1 HARDWARE STEP 1

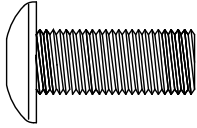

#32. 5/16" × 3/4" Button Head Socket Bolt (6 pcs)

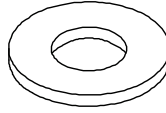

#33. 5/16" × 18 × 1.5T Flat Washer (10 pcs)

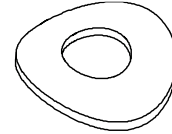

#34. 5/16" × 19 × 1.5T Curved Washer (1 pc)



#41. M5 × 12L Phillips Head Screw (4 pcs)

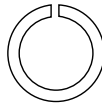

#35. 5/16" × 1.5T Split Washer (11 pcs)

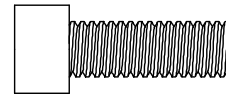

#112. 5/16" × 3/4" Socket Head Cap Bolt (5 pcs)

## 2 HARDWARE STEP 2

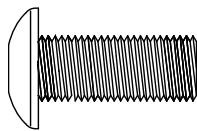

#32. 5/16" × 3/4" Button Head Socket Bolt (4 pcs)

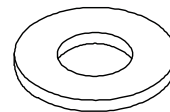

#33. 5/16" × 18 × 1.5T Flat Washer (4 pcs)

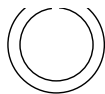

#35. 5/16" × 1.5T Split Washer (4 pcs)

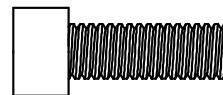

#112. 5/16" × 3/4" Socket Head Cap Bolt (4 pcs)

# 3 HARDWARE STEP 3

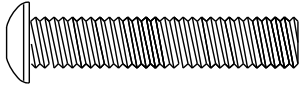

**#55.** M6 × 35L\_Phillips  
Head Screw (4 pcs)

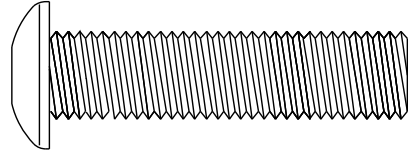

**#61.** 3/8" × 1-3/4" \_Button  
Head Socket Bolt (4 pcs)

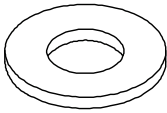

**#62.** 3/8" × 19 × 1.5T\_  
Flat Washer (6 pcs)

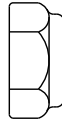

**#63.** 3/8" × 7T\_  
Nyloc Nut (6 pcs)

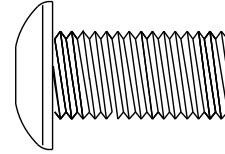

**#60.** 3/8" × 3/4"\_  
Button Head Socket Bolt  
(2 pcs)

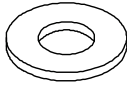

**#58.** 1/4" × 13 × 1T\_  
Flat Washer (4 pcs)



**#59.** 1/4" × 1"\_  
Phillips Head Screw  
(4 pcs)

# ASSEMBLY TOOLS

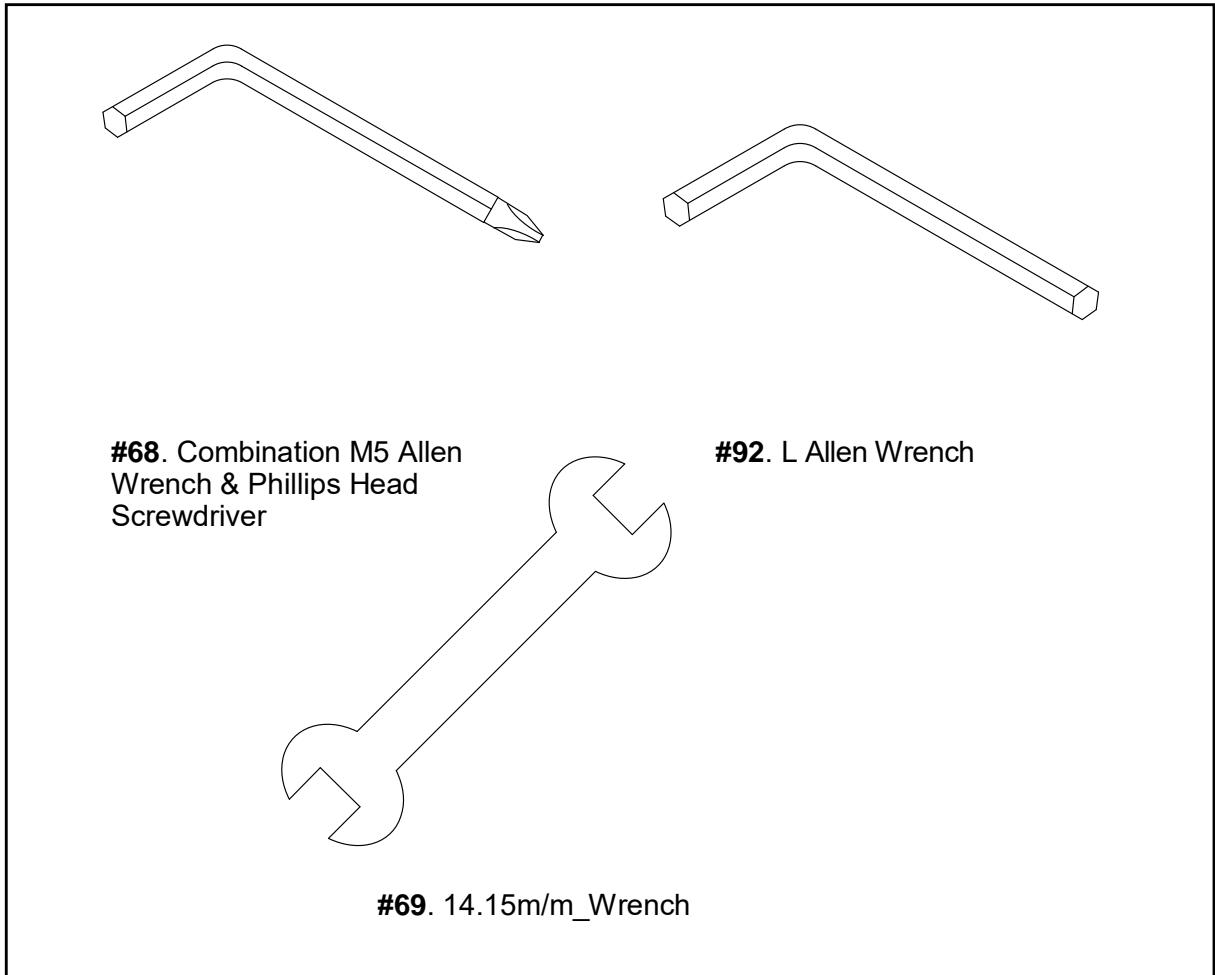

## ASSEMBLY INSTRUCTIONS

### PRE-ASSEMBLY

1. Using a razor knife (Box Cutter), cut the outside, bottom, edge of box along the dotted line. Lift Box over the unit and unpack.
2. Carefully remove all parts from carton and inspect for any damage or missing parts. If damaged parts are found or parts are missing, contact your dealer immediately.
3. Locate the hardware package. Remove the tools first. Remove the hardware for each step as needed to avoid confusion. The numbers in the instructions that are in parenthesis (#) are the item number from the assembly drawing for reference.
4. The hardware could be found on the cycle or found in the hardware bag for each step.



# 1 STEP

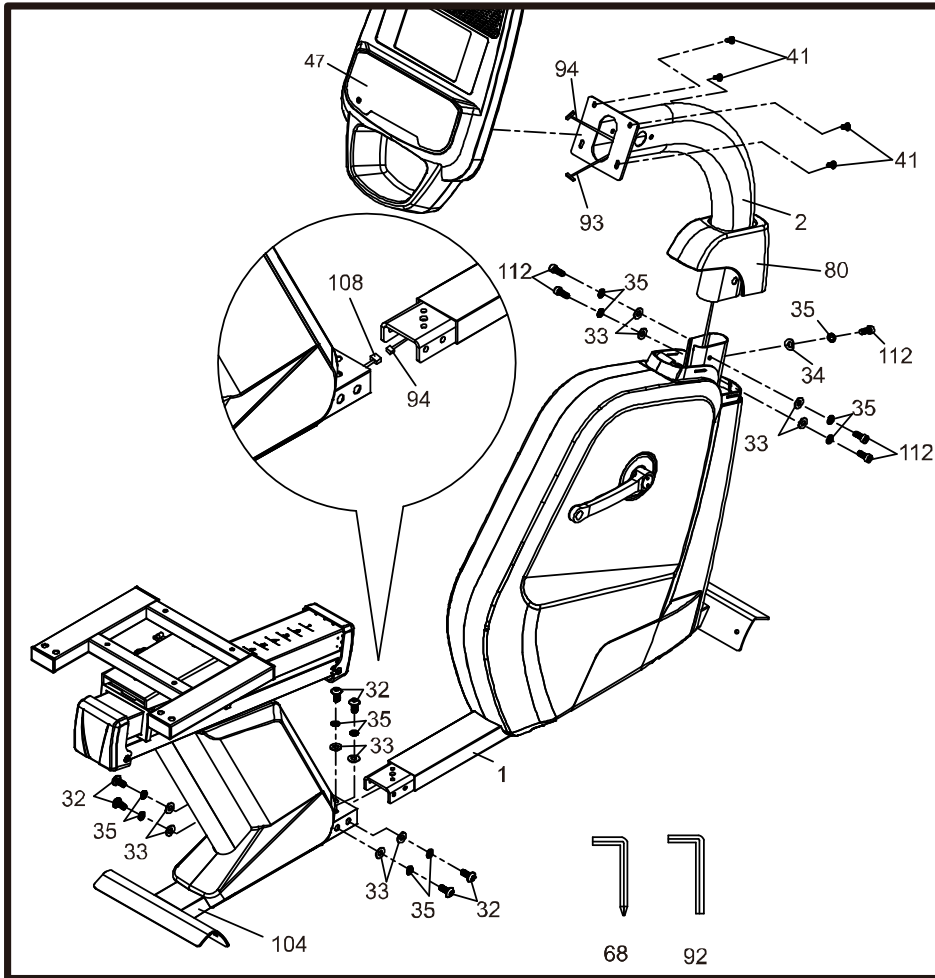

## HARDWARE STEP 1

#32. 5/16" x 3/4" Button Head Socket Bolt (6 pcs)  
#33. 5/16" x 18 x 1.5T Flat Washer (10 pcs)  
#34. 5/16" x 19 x 1.5T Curved Washer (1 pcs)  
#41. M5 x 12L Phillips Head Screw (4 pcs)  
#35. 5/16" x 1.5T Split Washer (11 pcs)  
#112. 5/16" x 3/4" Socket Head Cap Bolt (5 pcs)

1. First, connect the Handpulse Wire (Middle) (108) and the Handpulse Wire (Upper) (94) together, then join the Rear Main Frame (104) and the Front Main Frame (1) together and use the Combination M5 Allen Wrench & Phillips Head Screwdriver (68) to tighten six 5/16" x 3/4" Button Head Socket Bolts (32), six 5/16" x 1.5T Split Washers (35) and six 5/16" x 18 x 1.5T Flat Washers (33).
2. Install the Console Mast (2) through the Console Mast Cover (80) and attach it to the mainframe. Use the L Allen Wrench (92) to tighten 5pcs of 5/16" x 3/4" Socket Head Cap Bolt (112), 5pcs of 5/16" x 1.5T Split Washer (35), 4pcs of 5/16" x 18 x 1.5T Flat Washers (33) and 1pcs of 5/16" x 19 x 1.5T Curved Washer (34) then cover with the Console Mast Cover (80).
3. Connect the Computer Cable (93) and Handpulse Wire (Upper) (94) to the Console (47). Attach the Console (47) to the Console Mast (2) using the Combination M5 Allen Wrench & Phillips Head Screwdriver (68) to tighten 4pcs of M5 x 12L Phillips head screws (41).

# 2 STEP

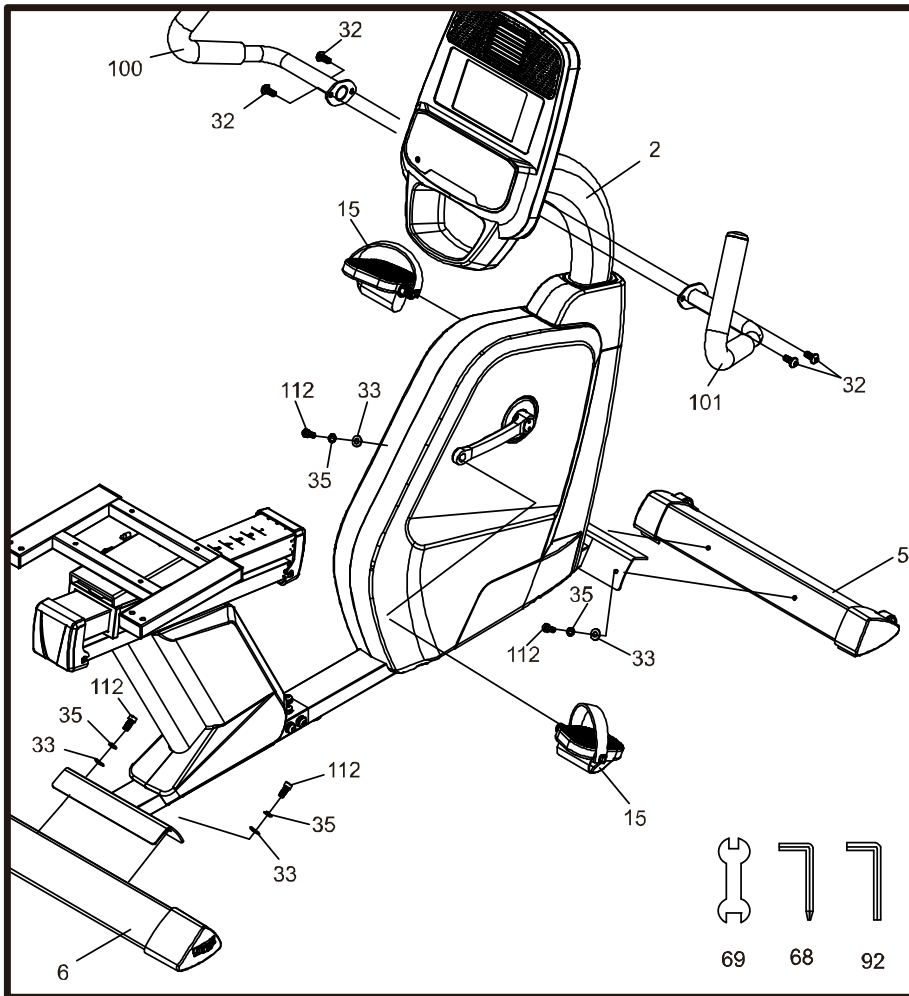

## HARDWARE STEP 2

- #32. 5/16" × 3/4" Button Head Socket Bolt (4 pcs)
- #33. 5/16" × 18 × 1.5T Flat Washer (4 pcs)
- #35. 5/16" × 1.5T Split Washer (4 pcs)
- #112. 5/16" × 3/4" Socket Head Cap Bolt (4 pcs)

1. Use the L Allen Wrench (92) to tighten the front and rear stabilizers (5, 6) on the mounting brackets with 4pcs of 5/16" × 3/4" Socket Head Cap Bolt (112), 4pcs of 5/16" × 1.5T Split Washers (35) and 4pcs of 5/16" × 18 × 1.5T Flat Washers (33).
2. Use the 14.15m/m Wrench (69) to tighten both pedals (15) onto the crank arms.  
Note: the right pedal is inserted to the crank clockwise, and the left pedal is inserted counterclockwise.
3. Tighten four 5/16" × 3/4" Button Head Socket Bolts (32) with the Combination M5 Allen Wrench & Phillips Head Screwdriver (68) to Secure the left and right-Hand Pulse Sensor Arms (100, 101) on the Console Mast (2).

# 3 STEP

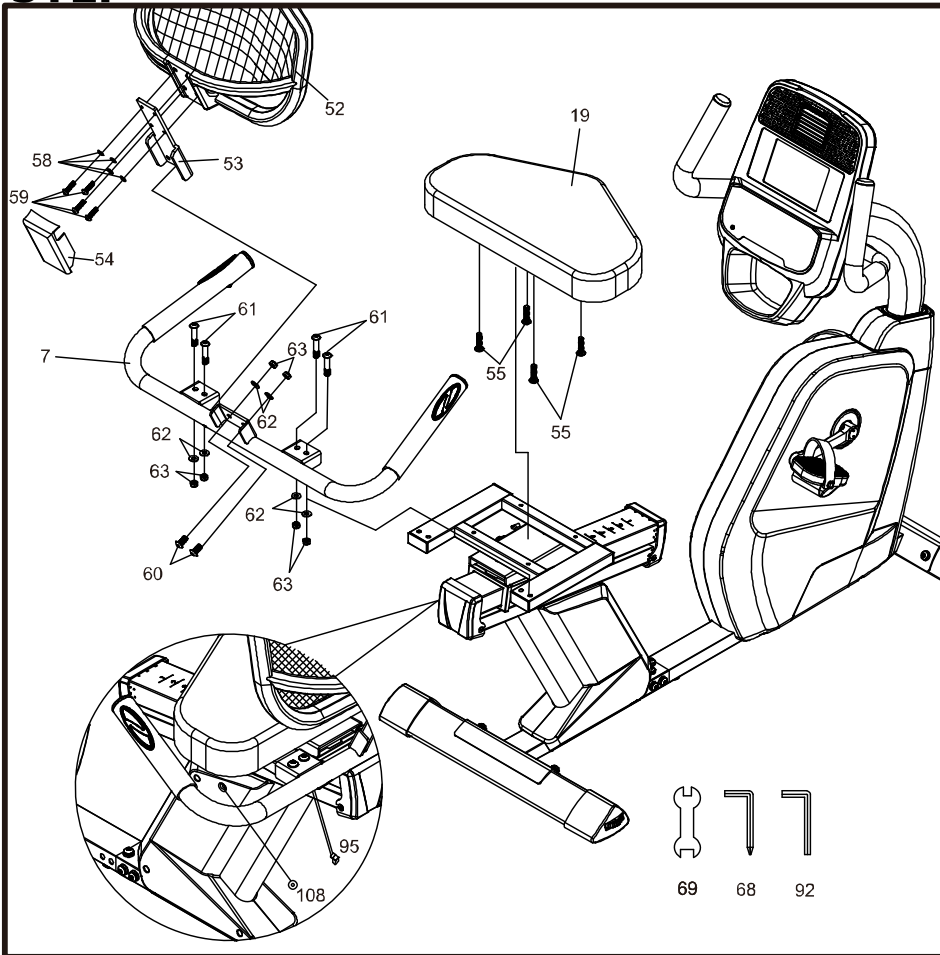

## HARDWARE STEP 3

- #55. M6 x 35L\_ Phillips Head Screw (4 pcs)
- #61. 3/8" x 1-3/4" Button Head Socket Bolt (4 pcs)
- #62. 3/8" x 19 x 1.5T Flat Washer (6 pcs)
- #63. 3/8" x 7T Nyloc Nut (6 pcs)
- #60. 3/8" x 3/4" Button Head Socket Bolt (2 pcs)
- #58. 1/4" x 13 x 1T Flat Washer (4 pcs)
- #59. 1/4" x 1" Phillips Head Screw (4 pcs)

1. Secure the Seat (19) to the sliding seat carriage by using the Combination M5 Allen Wrench & Phillips Head Screwdriver (68) to tighten 4pcs of M6 x 35L Phillips Head Screws (55).
2. Install the Seat Handlebar (7) on the sliding seat carriage by using the L Allen Wrench (92) to tighten 4pcs of 3/8" x 1-3/4" Button Head Socket Bolts (61), going through the Seat Handlebar (7) and 4pcs of 3/8" x 19 x 1.5T Flat Washers (62), then use the 14.15m/m Wrench (69) to tighten 4pcs of 3/8" x 7T Nyloc Nuts (63).
3. Install the Backrest Bracket (53) on the Seat Handlebar (7) by using the L Allen Wrench (92) to tighten 2pcs of 3/8" x 3/4" Button Head Socket Bolts (60), going through the Seat Handlebar (7) and 2pcs of 3/8" x 19 x 1.5T Flat Washers (62), then use the 14.15m/m Wrench (69) to tighten 2pcs of 3/8" x 7T Nyloc Nuts (63).
4. Install the Backrest (52) on the Backrest Bracket (53) by using the Combination M5 Allen Wrench & Phillips Head Screwdriver (68) to tighten four 1/4" x 1" Phillips Head Screws (59) and four 1/4" x 13 x 1T Flat Washers (58), then cover the Backrest Bracket (53) with the Backrest Cover (54).
5. Connect the Lower and Middle handpulse wires (95, 108).

# OPERATION OF YOUR CONSOLE



## Power Up

This model requires DC 12V transformer power supply. Connect the power cable to the socket on the left side of the machine near the front.

With the power on, the console will be turned on and have a long beep sound with LCD full display for 2 seconds. Then it will display the version for 3 seconds before entering the USER mode.

## Functions:

1. **MANUAL:** Setting workout by manual, include target value setting of TIME, CAL, DIST, PULSE.
2. **PROGRAM:** P1~P13, 13 program profiles can be selected.
3. **FAT BURN:** Preset fat burning workout program
4. **CARDIO:** Preset oxygen sport workout program
5. **HILL:** Preset Hill workout program
6. **HIIT:** Preset Hiit workout program
7. **HRC:** The load is controlled by the heart rate automatic; there are six options 50%, 60%, 70%, 80%, 90%, and TARGET.
8. **USER DEFINE:** User can set his or her program profile.

## Button Functions:

1. **START:** Start workout
2. **STOP:** Workout pause, and press again back to standby mode. Press and hold the button, console will restart.
3. **ENTER:** Confirm the function or setting value.
4. **LEVEL +:** Increase the load or upward the setting value such as TIME.
5. **LEVEL -:** Decrease the load of downward the setting value such as TIME.
6. **FAN:** Fan function ON/OFF.
7. **MANUAL:** In the standby mode, press MANUAL quick key into MANUAL mode.
8. **PROGRAM:** In the standby mode, press PROGRAM quick key into PROGRAM mode.
9. **FAT BURN:** In the standby mode, press FAT BURN quick key into FAT BURN mode.
10. **CARDIO:** In the standby mode, press CARDIO quick key into CARDIO mode.
11. **HILL:** In the standby mode, press HILL quick key into HILL mode.
12. **HIIT:** In the standby mode, press HIIT quick key into HIIT mode.
13. **HRC:** In the standby mode, press HRC quick key into HRC mode.
14. **USER DEFINE:** In the standby mode, press USER quick key into USER DEFINE mode.

## Operation:

1. Console power on with beep sound, and LCD full display for 2 seconds (image 1), then showing the version and model for 3 seconds. After that, enter USER data setting. There are 4 sets of USER data settings, press [**LEVEL+ / LEVEL-**] to select, and press [**ENTER**] to confirm. Setting process: USER → AGE → WEIGHT (image 2~image 4); After setting, press enter to start standby mode. (image 5).

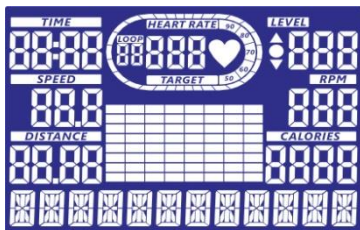

Image 1



Image 2



Image 3



Image 4



Image 5

2. **In the standby mode**, press[**START**]to QUICK START and enter Manual mode to start workout. Or, press[**LEVEL+/LEVEL-**]to select Manual, Program, Fat burn, Cardio, Hill, Hiit, HRC and User define (image 6~image 13), then press[**ENTER**]to confirm. Or, directly press function Quick key to quick enter.



image 6

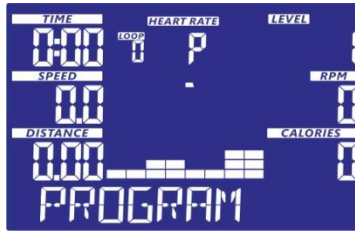

image 7

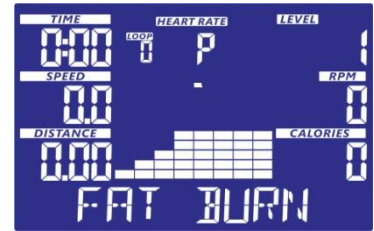

image 8



image 9

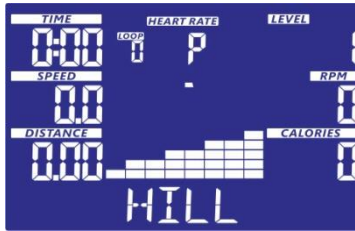

image 10

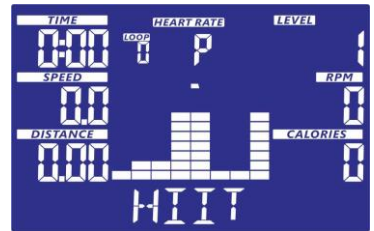

image 11



image 12

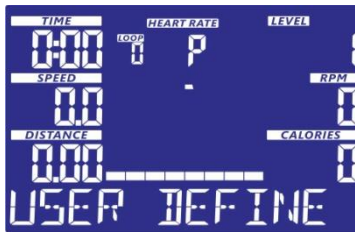

image 13



3. **Manual mode:** In standby mode, press[**LEVEL+ / LEVEL-**]to select MANUAL, and press[**ENTER**]. Or, press[**MANUAL**]quick key to enter this mode directly. Then, set the target value in sequence TIME→DISTANCE→CALORIES→HEART RATE (image 14~image 17) by pressing[**LEVEL+ / LEVEL-**]to adjust, and press [**ENTER**]into next value setting. After setting, press [**START**] to start workout, and press[**LEVEL+ / LEVEL-**] to adjust the load during workout. Press[**STOP**]to pause workout, and press[**STOP**]again back to the standby mode. With one value of TIME, DISTANCE, and CALORIES preset target value will count down to zero; the workout will be stopped, all the values stop counting. Press[**STOP**]to leave this mode and return to standby mode.



image 14

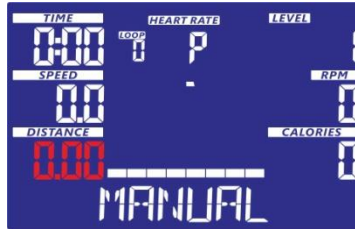

image 15



image 16



image 17

4. **Program mode:** In standby mode, press[**LEVEL+ / LEVEL-**]to select PROGRAM, and press[**ENTER**]. Or, press[**PROGRAM**]quick key to enter this mode directly. First, select program profiles (image 18) total 13 sets. Press [**ENTER**]to confirm the profiles and set target TIME (image 19) by pressing[**LEVEL+ / LEVEL-**]to adjust. After setting, press[**START**]to start workout, and press[**LEVEL+ / LEVEL-**]to adjust the load during workout. Press[**STOP**]to pause workout and press [**STOP**] again back to the standby mode. When preset the target TIME, the target value will count down to zero, the workout will be stopped, and all the values stop counting. Press[**STOP**]to leave this mode and return to standby mode.

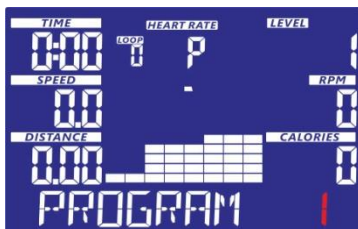

image 18

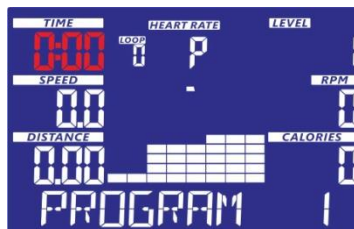

image 19

5. **Fat Burn mode:** In standby mode, press[**LEVEL+ / LEVEL-**]to select FAT BURN and press[**ENTER**]. Or, press[**FAT BURN**]quick key to enter this mode directly. Then, set target TIME (image 20) by pressing[**LEVEL+ / LEVEL-**]to adjust. After setting, press[**START**]to start workout, and press [**LEVEL+ / LEVEL-**]to adjust the load during workout. Press[**STOP**]to pause workout and press [**STOP**] again back to the standby mode. When preset the target TIME, the target value will count down to zero, the workout will be stopped, and all the values stop counting. Press[**STOP**]to leave this mode and return to standby mode.

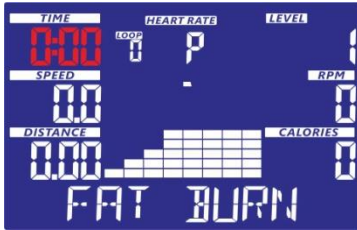

image 20

6. **Cardio mode:** In standby mode, press[**LEVEL+ / LEVEL-**]to select CARDIO and press[**ENTER**]. Or, press[**CARDIO**]quick key to enter this mode directly. Then, set target TIME (image 21) by pressing[**LEVEL+ / LEVEL-**]to adjust. After setting, press[**START**]to start workout, and press[**LEVEL+ / LEVEL-**]to adjust the load during workout. Press [**STOP**] to pause workout, and press [**STOP**] again back to the standby mode. When preset the target TIME, the target value will count down to zero, the workout will be stopped, and all the values stop counting. Press[**STOP**]to leave this mode and return to standby mode.



image 21

7. **Hill mode:** In standby mode, press[**LEVEL+ / LEVEL-**]to select HILL, and press[**ENTER**]. Or, press[**HILL**]quick key to enter this mode directly. Then, set target TIME (image 22) by pressing[**LEVEL+ / LEVEL-**]to adjust. After setting, press[**START**]to start workout, and press [**LEVEL+ / LEVEL-**]to adjust the load during workout. Press [**STOP**]to pause workout, and press[**STOP**] again back to the standby mode. When preset the target TIME, the target value will count down to zero, the workout will be stopped, and all the values stop counting. Press [**STOP**]to leave this mode and return to standby mode.



image 22

8. **HIIT mode:** In standby mode, press[**LEVEL+ / LEVEL-**]to select Hiit and press[**ENTER**]. Or, press[**HIIT**]quick key to enter this mode directly. Then, set target TIME (image 23) by pressing[**LEVEL+ / LEVEL-**]to adjust. After setting, press[**START**]to start workout, and press[**LEVEL+ / LEVEL-**]to adjust the load during workout. Press [**STOP**] to pause workout, and press [**STOP**] again back to the standby mode. When preset the target TIME, the target value will count down to zero, the workout will be stopped, and all the values stop counting. Press[**STOP**]to leave this mode and return to standby mode.

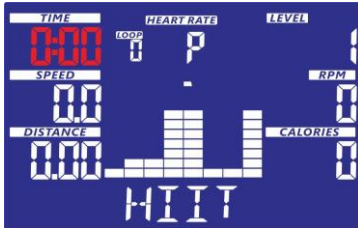

image 23

9. **HRC mode:** In standby mode, press[**LEVEL+ / LEVEL-**]to select HRC, and press [**ENTER**]. Or, press[**HRC**]quick key to enter this mode directly. First, select HRC 50%, 60%, 70%, 80%, 90%, or TARGET HRC (image 24~image 29) total 6 sets. TARGET HRC is able to set the target pulse value. After entering to the TARGET HRC, you need to set the target pulse value (image 30) and press[**ENTER**]to confirm, then enter to the target Time setting (image 31). When you select HRC % and press[**ENTER**], it will enter to target TIME setting directly (image 31), except TARGET HRC. After setting, press[**START**]to start workout. The load will automatically change according to the pulse and cannot be adjusted manually. Therefore, the console needs to keep receiving pulse signal in this mode. Press[**STOP**]to pause workout, and press[**STOP**]again back to the standby mode. When preset the target TIME, the target value will count down to zero, the workout will be stopped, and all the values stop counting. Press[**STOP**]to leave this mode and return to standby mode. If there is no pulse signal during workout, the console will show "CHECK PULSE" (image 32), and after 1 minute, it will be back to standby mode. If the current pulse is over target pulse, the console will have beep sound as warning signal. Keep having warning sound 30 seconds, the workout will be stopped, and all the values stop counting. Press[**STOP**]to leave this mode and return to standby mode.



image 24



image 25



image 26



image 27



image 28



image 29



image 30



image 31

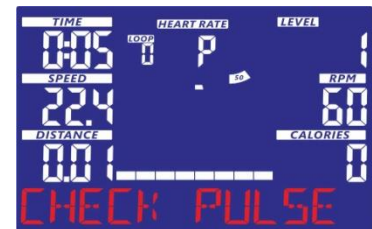

image 32

10. **User Define mode:** In standby mode, press[**LEVEL+ / LEVEL-**]to select USER DEFINE, and press [**ENTER**]. Or, press[**USER**]quick key to enter this mode directly. User may press[**LEVEL+ / LEVEL-**] and then press [**ENTER**]to create his own profile from column 1 to column 20 (image 33). The heart rate window will display the number of rows, and the load window will display the load value for the current setting. After load setting, press and hold[**ENTER**]to enter TIME setting (image 34). Then, set target TIME by pressing [**LEVEL+ / LEVEL-**]to adjust. After that, press[**START**]to start workout, and press [**LEVEL+ / LEVEL-**]to adjust the load during workout. Press[**STOP**]to pause workout, and press[**STOP**]again back to the standby mode. When preset the target TIME, the target value will count down to zero, the workout will be stopped, and all the values stop counting. Press[**STOP**]to leave this mode and return to standby mode.

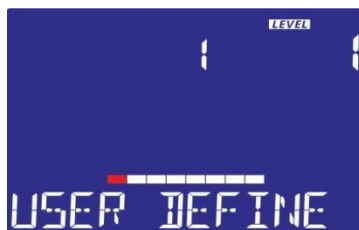

image 33



image 34

11. **Factory Setting mode:** In standby mode, press[ENTER]and[LEVEL+] for 2 seconds to enter factory setting mode. In this mode, press[LEVEL+/LEVEL-]to select, and press[ENTER]to the next setting. When the last option is set, press[ENTER]or press[STOP]during setting, the setting value will be stored and restarted.

### Option items

1. UNIT(KM/ML) -Set to English or Metric display readings
2. BRIGHT (0~15) -Adjust backlight brightness
3. SPECIAL (YES/NO) -Pull wire motor for special drive action
4. MAX LOAD (16 20 24 32) -Set the maximum resistance value
5. UX DATA (ON/OFF) -4 sets of user option switches
6. WHEEL (10~99) -Wheel setting

The exercise equipment can also play music wirelessly via Bluetooth. Turn on your mobile phone or tablet's Bluetooth function. Search for the name "Bt-speaker" in your device's Bluetooth menu. Tap to connect. Now your device can transmit music to the exercise equipment.

## GENERAL MAINTENANCE

1. Wipe down all areas in the sweat path with a damp cloth after each workout.
2. If a squeak, thump, clicking or rough feeling develops, the main cause is most likely one of two reasons:
  - i. The hardware was not sufficiently tightened during assembly. All bolts that were installed during assembly need to be tightened as much as possible. It may be necessary to use a larger wrench than the one provided if you cannot tighten the bolts sufficiently. **90% of customer service calls for noise issues can be traced to loose hardware or the rear rails being dirty.**
  - ii. The crank arm nut and/or the pedals need to be retightened.
3. If squeaks or other noises persist, check that the unit is properly levelled before calling the service department.

# PROGRAM PROFILES

## PROGRAM MOTION PROFILES 1~13

### PROGRAM 1, Muscle Endurance:

Muscle endurance is the ability of a muscle to maintain for a long time under load resistance. The muscular endurance program utilizes overload resistance training to allow the muscles to withstand high loads, stimulate physiological disturbances, and enhance muscle tissue adaptability, which is the most effective way to increase muscle endurance.

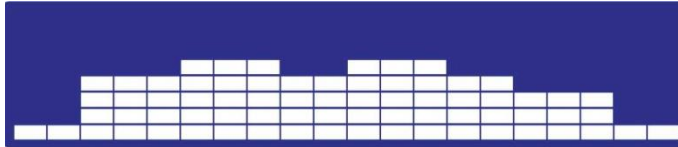

### PROGRAM 2, Core Muscles:

The core muscles must be continuously trained to maintain muscle strength. The core muscle program is able to maintain the consistency of exercise and keep the body stable without shaking so that the body can use each muscle more precisely.



### PROGRAM 3, Simulation:

Simulation is similar to the mountaineering method. The slopes encountered in the mountains are different, the resistance is stronger, and the training of the leg muscles is strengthened. The curve of the lower body and the body can be sculptured to achieve the effect of lifting the hips and sculpting.



### PROGRAM 4, Aerobic Exercise:

The aerobic exercise program improves cardiovascular conditioning and assists in weight management. This program allows the user to maintain a heart rate of 50% to 90% of a users maximum heart rate.





**PROGRAM 5, Thrill Hill:**

The Thrill Hill program combines a few types of workouts in one, with variations of cardio and strength portions to give you a thrill.

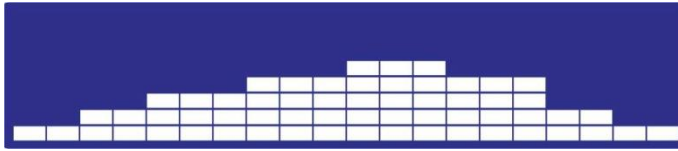

**PROGRAM 6, X-Sport:**

The X-sport program is designed to increase muscular strength in your lower body with extreme resistance. This program will steadily increase in resistance to a high level and then keeps you there. A great all around workout.



**PROGRAM 7, Cardiopulmonary:**

The cardiopulmonary program strengthens the lungs and heart, allowing users to carry oxygen from the air and transport oxygen to tissue cells for use. Allows users to achieve a maximum heart rate of 60-80% during exercise.



**PROGRAM 8, Off-Road:**

The off-road program simulates a cross-country race. In the process, you will experience the challenge of steep climbs and the relief of downhill sprints. A great all-around training program.



**PROGRAM 9, Wild Ride:**

The Wild Ride program is designed to increase your cardiovascular function. This exercise is designed for your heart and lungs. It will build up your heart muscle and increase blood flow and lung capacity. This is achieved by incorporating a higher level of exertion with slight fluctuations in work levels. A real Wild Ride!



**PROGRAM 10, Limit Mode:**

The Limit mode program was designed to provide continuous resistance, helping the body increase fat consumption. This program gradually increases the resistance and maintains a constant intensity. This program design allows the user to strengthen and adapt their physical condition.

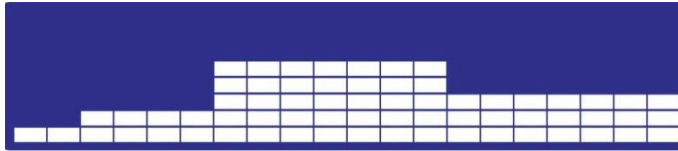

**PROGRAM 11, Low-Intensity Training:**

The low intensity training program provides lower resistance making it ideal for beginners. When you maintain a lower resistance, you place less strain on your joints, ligaments, and tendons. Such training does not tax the body and therefore reduces the risk of injury while still providing the cardiovascular benefits of exercise.



**PROGRAM 12, Canyons:**

The Canyons program takes you through high levels of intensity, followed by periods of low intensity. This program increases your endurance by depleting your oxygen level, followed by periods of recovery to replenish oxygen. Your cardiovascular system gets programmed to use oxygen more efficiently this way.



**PROGRAM 13, Resistance Training:**

Using external resistance to train, the resistance generated by training equipment can achieve the effect of muscle contraction, increase muscle strength and endurance, and promote aerobic fitness.



### **FAT BURN:**

The Fat Burn program is designed, as the name implies, to maximize the burning of fat. There are many schools of thought on the best way to burn fat, but most experts agree that a lower exertion level that stays at a steady workload is the best. The absolute best way to burn fat is to keep your heart rate at around 60% to 70% of its maximum potential. This program does not use heart rate but simulates a lower, steady exertion workout.

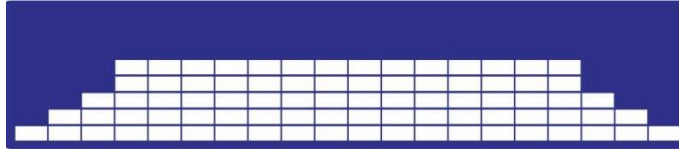

### **CARDIO:**

The Cardio program is designed to increase your cardiovascular function and endurance. This is exercise for your heart and lungs. It will build up your heart muscle and increase blood flow and lung capacity. This is achieved by incorporating a higher level of exertion with slight fluctuations in work.



### **HILL:**

The Hill program simulates going up and down a hill. The resistance in the pedals will steadily increase and then decrease during the program.

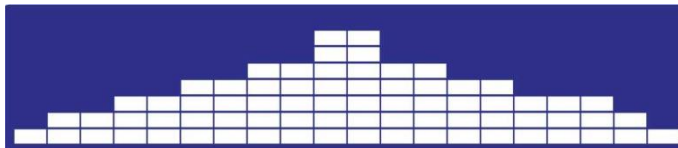

### **HIIT:**

The Hiit program takes you through high levels of intensity, followed by periods of low intensity. This program increases your endurance by depleting your oxygen level, followed by periods of recovery to replenish oxygen. Your cardiovascular system gets programmed to use oxygen more efficiently this way. This program also forces your body to become more efficient due to spikes in heart rate between recovery periods. This aids in heart rate recovery from intense activities.



# HEART RATE

The old motto, "no pain, no gain," is a myth that has been overpowered by the benefits of exercising comfortably. A great deal of this success has been promoted by the use of heart rate monitors. With the proper use of a heart rate monitor, many people find that their usual choice of exercise intensity was either too high or too low, and exercise is much more enjoyable by maintaining their heart rate in the desired benefit range.

To determine the benefit range in which you wish to train, you must first determine your Maximum Heart Rate. This can be accomplished by using the following formula: 220 minus your age. This will give you the Maximum Heart Rate (MHR) for someone of your age. To determine the effective heart rate range for specific goals, you simply calculate a percentage of your MHR. Your heart rate training zone is 50% to 90% of your maximum heart rate. 60% of your MHR is the zone that burns fat, while 80% is for strengthening the cardiovascular system. This 60% to 80% is the zone to stay in for maximum benefit.

Example: The target heart rate zone for someone who is 40 years old is calculated below:

$220 - 40 = 180$  Maximum Heart Rate (MHR)  
 $180 \times .60 = 108$  beats per minute (60% of maximum)  
 $180 \times .80 = 144$  beats per minute (80% of maximum)

So for a 40-year-old, the training zone would be 108 to 144 beats per minute.

If you enter your age during programming, the console will perform this calculation automatically. After calculating your MHR, you can decide upon which goal you would like to pursue.

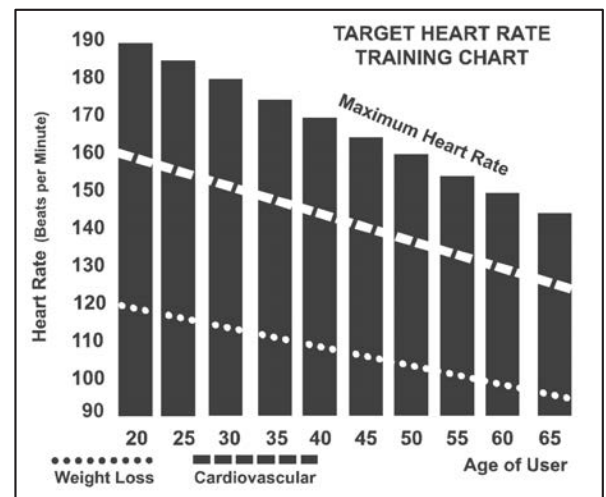

The two most popular reasons for, or goals, of exercise are cardiovascular fitness (training for the heart and lungs) and weight control. The black columns on the chart above represent the MHR for a person whose age is listed at the bottom of each column. The training heart rate, for either cardiovascular fitness or weight loss, is represented by two different lines that cut diagonally through the chart. A definition of the lines' goal is in the bottom left-hand corner of the chart. If your goal is cardiovascular fitness or if it is weight loss, it can be achieved by training at 80% or 60%, respectively, of your MHR on a schedule approved by your physician. Consult your physician before participating in any exercise program.

# RATE OF PERCEIVED EXERTION

Heart rate is important but listening to your body also has a lot of advantages. There are more variables involved in how hard you should work out than just heart rate. Your stress level, physical health, emotional health, temperature, humidity, the time of day, the last time you ate and what you ate all contribute to the intensity at which you should workout. If you listen to your body, it will tell you all of these things.

The rate of perceived exertion (RPE), also known as the Borg scale, was developed by Swedish physiologist G.A.V. Borg. This scale rates exercise intensity from 6 to 20 depending upon how you feel or the perception of your effort.

The **Borg Scale** is as follows:

## Rating Perception of Effort

- 6** Minimal
- 7** Very, very light
- 8** Very, very light +
- 9** Very light
- 10** Very light +
- 11** Fairly light
- 12** Comfortable
- 13** Somewhat hard
- 14** Somewhat hard +
- 15** Hard
- 16** Hard +
- 17** Very hard
- 18** Very hard +
- 19** Very, very hard
- 20** Maximal

You can get an approximate heart rate level for each rating by simply adding a zero to each rating. For example, a rating of 12 will result in an approximate heart rate of 120 beats per minute. Your RPE will vary depending on the factors discussed earlier. That is the major benefit of this type of training. If your body is strong and rested, you will feel strong, and your pace will feel easier. When your body is in this condition, you are able to train harder, and the RPE will support this. If you are feeling tired and sluggish, it is because your body needs a break. In this condition, your pace will feel harder. Again, this will show up in your RPE, and you will train at the proper level for that day.

# USING HEART RATE TRANSMITTER (Optional)

How to wear your wireless chest strap transmitter:

1. Attach the cycle to the elastic strap using the locking parts.
2. Adjust the strap as tightly as possible as long as the strap is not too tight to remain comfortable.
3. Position the transmitter with the centre in the middle of your body facing away from your chest (some people must position the transmitter slightly left of center). Attach the final end of the elastic strap by inserting the round end and, using the locking parts, secure the transmitter and strap around your chest.
4. Position the transmitter immediately below the pectoral muscles.
5. Sweat is the best conductor to measure very minute heartbeat electrical signals. However, plain water can also be used to pre-wet the electrodes (2 ribbed oval areas on the reverse side of the belt and both sides of the transmitter). It's also recommended that you wear the transmitter strap a few minutes before your workout. Some users, because of body chemistry, have a more difficult time in achieving a strong, steady signal at the beginning. After "warming up," this problem lessens. As noted, wearing clothing over the transmitter/strap doesn't affect performance.
6. Your workout must be within range - distance between transmitter/receiver - to achieve a strong, steady signal. The length of range may vary somewhat but generally stay close enough to the console to maintain good, strong, reliable readings. Wearing the transmitter immediately against bare skin assures you of proper operation. If you wish, you may wear the transmitter over a shirt. To do so, moisten the areas of the shirt that the electrodes will rest upon.



**Note:** The transmitter is automatically activated when it detects activity from the user's heart. Additionally, it automatically deactivates when it does not receive any activity. Although the transmitter is water-resistant, moisture can have the effect of creating false signals, so you should take precautions to completely dry the transmitter after use to prolong battery life (estimated transmitter battery life is 2500 hours). The replacement battery is Panasonic CR2032.

## ERRATIC OPERATION

**Caution!** Do not use this cycle for Heart Rate unless a steady, solid Actual Heart Rate value is being displayed. High, wild, random numbers being displayed indicate a problem.

Areas to look for interference that may cause erratic heart rate:

1. Microwave ovens, TVs, small appliances, fluorescent lights, etc.
2. Some household security systems.
3. Perimeter fence for a pet.
4. Some people have problems with the transmitter picking up a signal from their skin. If you have problems, try wearing the transmitter upside down. Usually, the transmitter will be oriented, so the logo is right-side up.
5. The antenna that picks up your heart rate is very sensitive. If there is an outside noise source, turning the whole machine 90 degrees may de-tune the interference.
6. Loose console or bolts in the upright tube.
7. Another individual wearing a transmitter within 3' of your machine's console.

If you continue to experience problems, contact your dealer.

**WARNING! - DO NOT USE THE HEART RATE PROGRAM IF YOUR HEART RATE IS NOT REGISTERING PROPERLY ON THE CYCLE'S DISPLAY!**



# EXPLODED VIEW DIAGRAM

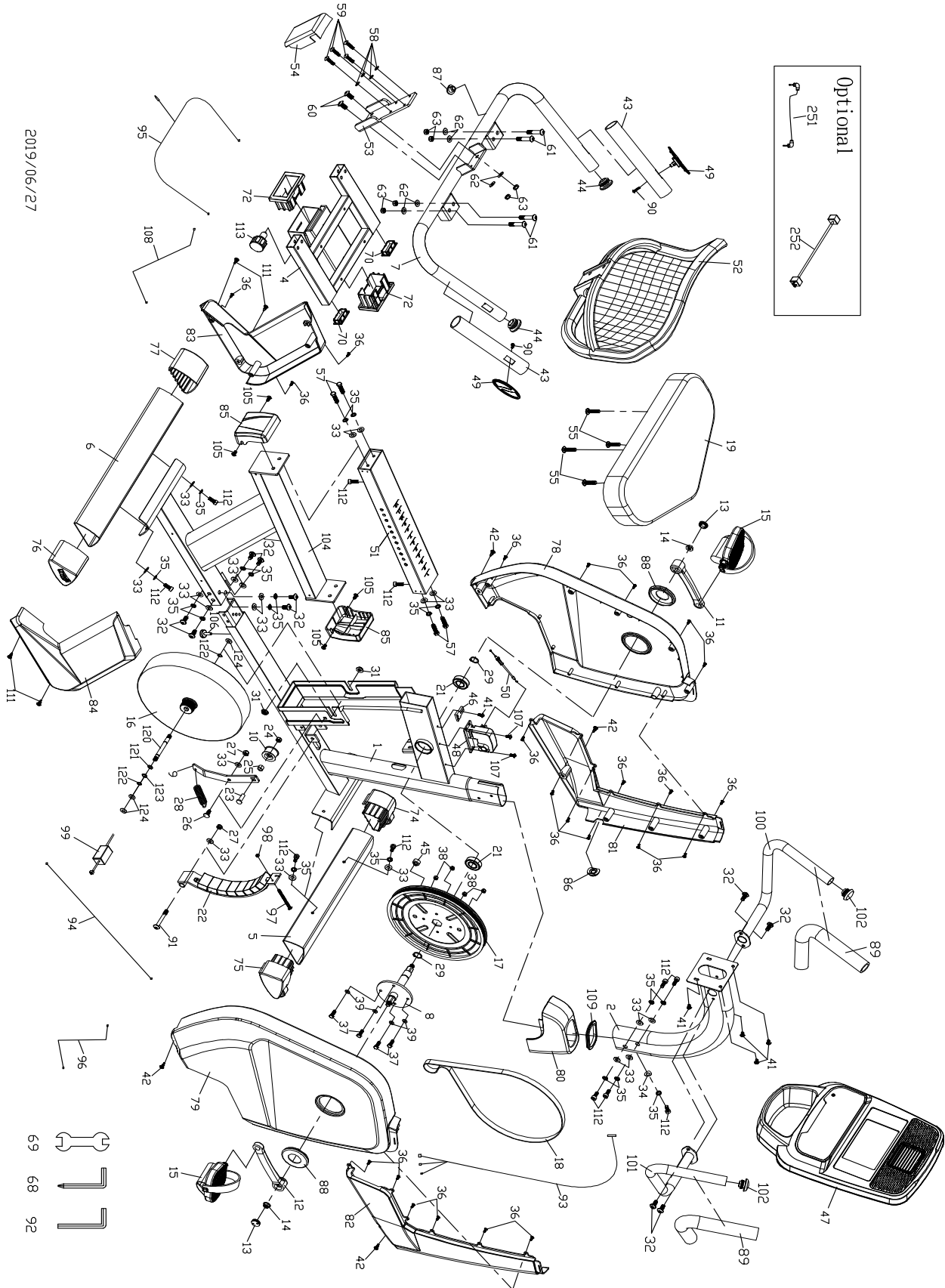

2019/06/27

Optional

251

252

- 96
- 69
- 68
- 92

# PARTS LIST

KEY NO.	PART NO.	Description	Q'TY
1	9835201	Main Frame	1
2	9835202	Console Mast	1
4	9835204	Seat Carriage	1
5	9835205	Front Stabilizer	1
6	9835206	Rear Stabilizer	1
7	9835207	Seat Handlebar	1
8	9835208	Crank Axle	1
9	9835209	Idler Bracket	1
10	9835210	Idler Wheel	1
11	9835211	Crank Arm (L)	1
12	9835212	Crank Arm (R)	1
13	9835213	Crank Arm End Cap	2
14	9835214	M10 × 7T_Nut	2
15	9835215	Pedals	2
16	9835216	Flywheel	1
17	9835217	Drive Pulley	1
18	9835218	Belt	1
19	9835219	Seat	1
21	9835221	6004_Bearing	2
22	9835222	Flywheel Magnets Mounting Plate	1
23	9835223	3/8" × 28L_Carriage Bolt	1
24	9835224	3/8" × 7T_Nyloc Nut	1
25	9835225	Ø15.8 × Ø10 × 9L_Sleeve	1
26	9835226	5/16" × 20L_Carriage Bolt	1
27	9835227	5/16" × 6T_Nyloc Nut	2
28	9835228	Spring	1
29	9835229	20m/m_C Ring	2
31	9835231	3/8" × UNF26 × 7T_Nut	2
32	9835232	5/16" × 3/4" _Button Head Socket Bolt	10
33	9835233	Ø5/16" × Ø18 × 1.5T_Flat Washer	20
34	9835234	Ø5/16" × 19 × 1.5T_Curved Washer	1
35	9835235	5/16" × 1.5T_Split Washer	19
36	9835236	4 × 12L_Sheet Metal Screw	23
37	9835237	1/4" × 5/8" _Hex Head Bolt	4
38	9835238	1/4" × 5.5L_Nyloc Nut	4
39	9835239	Ø1/4" × 13 × 1T_Flat Washer	4
41	9835241	M5 × 12L_Phillips Head Screw	5
42	9835242	5 × 19L_Tapping Screw	4
43	9835243	Ø29 × 195L × 3T_Handgrip Foam	2
44	9835244	Ø32 _Button Head Plug	2
45	9835245	Magnet	1
46	9835246	450m/m_Sensor W/Cable	1
47	9835247	Console	1
48	9835248	Gear Motor	1

KEY NO.	PART NO.	Description	Q'TY
49	9835249	Handpulse Sensor (w/o wire)	2
50	9835250	Steel Cable	1
51	9835251	Sliding Assembly	1
52	9835252	Seatback	1
53	9835253	Seat Back Bracket	1
54	9835254	Seatback Cover	1
55	9835255	M6 × 35L_Phillips Head Screw	4
57	9835257	5/16" × 1-1/4" _Hex Head Bolt	4
58	9835258	Ø1/4" × 13 × 1T_Flat Washer	4
59	9835259	1/4" × 1" _Phillips Head Screw	4
60	9835260	3/8" × 3/4" _Button Head Socket Bolt	2
61	9835261	3/8" × 1-3/4" _Button Head Socket Bolt	4
62	9835262	Ø3/8" × Ø19 × 1.5T_Flat Washer	6
63	9835263	3/8" × 7T_Nyloc Nut	6
68	9835268	Combination M5 Allen Wrench & Phillips Head Screwdriver	1
69	9835269	14.15m/m_Wrench	1
70	9835270	□25 × 50m/m_Square End Cap	2
72	9835272	Hollow Plug	2
74	9835274	Transportation Wheel(L)	1
75	9835275	Transportation Wheel(R)	1
76	9835276	Rear Adjustment Base (R)	1
77	9835277	Rear Adjustment Base (L)	1
78	9835278	Rear Shroud (L)	1
79	9835279	Rear Shroud (R)	1
80	9835280	Console Mast Cover	1
81	9835281	Front Shroud (L)	1
82	9835282	Front Shroud (R)	1
83	9835283	Seat Carriage Cover (L)	1
84	9835284	Seat Carriage Cover (R)	1
85	9835285	Track Endcap	2
86	9835286	Power Bracket	1
87	9835287	HGP Wire Grommet	1
88	9835288	Crank Arm Cover	2
89	9835289	Ø25.4 × 5T × 320L_Handgrip Foam	2
90	9835290	Ø4 × 20L_Sheet Metal Screw	2
91	9835291	5/16" × 65L_Button Head Socket Bolt	1
92	9835292	L Allen Wrench	1
93	9835293	1200m/m_Computer Cable	1
94	9835294	2150m/m_Handpulse Wire	1
95	9835295	Handpulse Wire (Lower)	1
96	9835296	300m/m_DC Power Cord	1
97	9835297	M5 × 75L_Phillips Head Screw	1
98	9835298	M5 × 5T_Nyloc Nut	1
99	9835299	Power Adaptor	1
100	98352100	Hand Pulse Sensor Arm (L)	1

KEY NO.	PART NO.	Description	Q'TY
101	98352101	Hand Pulse Sensor Arm (R)	1
102	98352102	Ø25.4 × 2T _Button Head Plug	2
104	98352104	Rear Main Frame	1
105	98352105	M5 × 20L _Phillips Head Screw	4
106	98352106	Foot Pad	1
107	98352107	M5 × 12L _Phillips Head Screw	2
108	98352108	550m/m _Handpulse Wire (Middle)	1
109	98352109	Console Mast End Cap	1
111	98352111	5 × 19L _Tapping Screw	4
112	98352112	5/16" × 3/4" _Socket Head Cap Bolt	11
113	98352113	Ø8 × M16 _Locking Knob	1
120	98352120	Axle	1
121	98352121	Ø12.4 × Ø19 × 0.5T _Flat Washer	1
122	98352122	Ø12 _C Ring	2
123	98352123	Ø12 _Wave Washer	1
124	98352124	Ø3/8" × Ø19 × 1.5T _Flat Washer	3
251	98352251	Audio Cable (Optional)	1
252	98352252	Transformer Power Cord	1

# MANUFACTURER'S LIMITED WARRANTY

Dyaco Canada Inc. warrants all its fitness bike parts for a period of time listed below from the date of retail sale, as determined by sale receipt. Dyaco Canada Inc.'s responsibilities include providing new or remanufactured parts at Dyaco Canada Inc.'s option and technical support to our independent dealers and servicing organizations. In the absence of a dealer or service organization, these warranties will be administered by Dyaco Canada Inc. directly to a consumer. The warranty period applies to the following components:

<b>Frame</b>	<b>lifetime</b>
<b>Parts</b>	<b>2 years</b>
<b>Labour</b>	<b>1 year</b>

This warranty applies only to products in ordinary household use, and the consumer is responsible for the items listed below:

1. The warranty registration can be completed online: Go to [www.dyaco.ca/warranty.html](http://www.dyaco.ca/warranty.html) and complete the online warranty registration.
2. Proper use of the fitness bike in accordance with the instructions provided in this manual.
3. Proper installation in accordance with instructions provided with the fitness bike and with all local electric codes.
4. Proper connection to a grounded power supply of sufficient voltage, replacement of blown fuses, repair of loose connections or defects in house wiring.
5. Expenses for making the fitness bike accessible for servicing, including any item that was not part of the fitness bike at the time it was shipped from the factory.
6. Damages to the fitness bike finish during shipping, installation or following installation.
7. Routine maintenance of this unit as specified in this manual.

## EXCLUSIONS

This warranty does not cover the following:

1. CONSEQUENTIAL, COLLATERAL, OR INCIDENTAL DAMAGES SUCH AS PROPERTY DAMAGE AND INCIDENTAL EXPENSES RESULTING FROM ANY BREACH OF THIS WRITTEN OR ANY IMPLIED WARRANTY.  
Note: Some provinces may not allow the exclusion or limitation of incidental or consequential damages, so this limitation or exclusion may not apply to you.
2. Service call reimbursement to the consumer. Service call reimbursement to the dealer that does not involve malfunction or defects in workmanship or material, for units that are beyond the warranty period, for units that are beyond the service call reimbursement period, for fitness bike not requiring component replacement, or fitness bike not in ordinary household use.
3. Damages caused by services performed by persons other than authorized Dyaco Canada Inc. service companies; use of parts other than original Dyaco Canada Inc. parts; or external causes such as corrosion, discoloration of paint or plastic, alterations, modifications, abuse, misuse, accident, improper maintenance, inadequate power supply, or acts of God.
4. Products with original serial numbers that have been removed or altered.
5. Products that have been: sold, transferred, bartered, or given to a third party.
6. Products that do not have a warranty registration on file at Dyaco Canada Inc. Dyaco Canada Inc. reserves the right to request proof of purchase if no warranty record exists for the product.
7. THIS WARRANTY IS EXPRESSLY IN LIEU OF ALL OTHER WARRANTIES EXPRESSED OR IMPLIED, INCLUDING THE WARRANTIES OF MERCHANTABILITY AND/OR FITNESS FOR A PARTICULAR PURPOSE.
8. Product use in any environment other than a residential setting.
9. Warranties outside of North America may vary. Please contact your local dealer for details.

## SERVICE

The sales receipt establishes the labour warranty period should service be required. If service is performed, it is in your best interest to obtain and keep all receipts. This written warranty gives you specific legal rights. Service under this warranty must be obtained by following these steps, in order:

1. Contact your selling authorized SOLE dealer or Dyaco Canada.
2. If you have any questions about your new product or questions about the warranty, contact Dyaco Canada Inc. at 1-888-707-1880.
3. If no local service is available, Dyaco Canada Inc. will repair or replace the parts, at Dyaco Canada Inc.'s option, within the warranty period at no charge for parts. All transportation costs, both to our factory and upon return to the owner, are the owner's responsibility.
4. The owner is responsible for adequate packaging upon return to Dyaco Canada Inc. Dyaco Canada Inc. is not responsible for damages that occur during shipping. Make all freight damage claims with the appropriate freight carrier. DO NOT SHIP ANY UNIT TO OUR FACTORY WITHOUT A RETURN AUTHORIZATION NUMBER. All units arriving without a return authorization number will be refused.
5. For any further information, or to contact our service department by mail, send your correspondence to:  
Dyaco Canada Inc.  
5955 Don Murie Street  
Niagara Falls, ON  
L2G 0A9

Product features or specifications as described or illustrated are subject to change without notice.  
All warranties are made by Dyaco Canada Inc.

# dyaco

Please visit us online for information about our other brands and products manufactured and distributed by Dyaco Canada Inc.

**SPIRIT**

[spiritfitness.ca](http://spiritfitness.ca)

**XTEERRA**

[xterrafitness.ca](http://xterrafitness.ca)

**UFC**

[dyaco.ca/UFC/UFC-home.html](http://dyaco.ca/UFC/UFC-home.html)

**SOLE**  
FITNESS

[solefitness.ca](http://solefitness.ca)

**EVERLAST**

[dyaco.ca/products/everlast.html](http://dyaco.ca/products/everlast.html)

**Johnny G**  
by **SPIRIT**

[spiritfitness.ca/johnnyg.html](http://spiritfitness.ca/johnnyg.html)

**TRAINOR**  
**SPORTS**

[trainorsports.ca](http://trainorsports.ca)

For more information, please contact Dyaco Canada Inc.

T: 1-888-707-1880 | 5955 Don Murie St., Niagara Falls, Ontario L2G 0A9 | [sales@dyaco.ca](mailto:sales@dyaco.ca)

Dyaco Canada Inc. [dyaco.ca](http://dyaco.ca)



**SOLE**  
FITNESS™