

SOLE
FITNESS

OWNER'S MANUAL
Model: 16008300900
ST90 Slat-Belt Treadmill

Please carefully read this entire manual
before operating your new treadmill.

ATTENTION: Before returning your SOLE product to any retailer, or if you require any assistance with assembly or technical support please call us first for assistance at 1-888-707-1880. Thank you for your SOLE purchase.

TABLE OF CONTENTS

<u>Product Registration</u>	1
<u>Important Safety Instructions</u>	2
<u>Important Electrical Information</u>	3
<u>Important Operation Instructions</u>	4
<u>Assembly instructions</u>	6
<u>Operation of Your New Treadmill</u>	10
<u>Bluetooth® Connectivity</u>	18
<u>Charging Function</u>	19
<u>Service Checklist - Diagnosis Guide</u>	24
<u>General Maintenance</u>	26
<u>Exploded View Diagram</u>	27
<u>Parts List</u>	28
<u>Manufacturer's Limited Warranty</u>	31

SOLE

FITNESS

CONGRATULATIONS ON YOUR NEW TREADMILL AND WELCOME TO THE SOLE FAMILY!

Thank you for your purchase of this quality treadmill from Dyaco Canada Inc. Your new treadmill has been manufactured by one of the leading fitness manufacturers in the world and is backed by one of the most comprehensive warranties available. Dyaco Canada Inc. will do all we can to make your ownership experience as pleasant as possible for many years to come.

If you have any questions about your new Sole product or questions about the warranty, contact Dyaco Canada Inc. at 1-888-707-1880.

Please take a moment to record below the name of the dealer, their telephone number and the date of purchase for easy contact in the future. We appreciate your confidence in **SOLE** and will always remember that you are the reason we are in business. Please go to www.dyaco.ca/warranty and complete the online warranty registration.

Yours in Health,
Dyaco Canada Inc.

Name of Dealer: _____

Telephone Number of Dealer: _____

Purchase Date: _____

PRODUCT REGISTRATION

RECORD YOUR SERIAL NUMBER

Please record the Serial Number of this fitness product in the space provided below.



REGISTER YOUR PURCHASE

Please visit us at www.dyaco.ca/warranty to register your purchase.

IMPORTANT SAFETY INSTRUCTIONS

WARNING - Read all instructions before using this exercise equipment.

DANGER - To reduce the risk of electric shock disconnect your SOLE treadmill from the electrical outlet before cleaning and/or service work.

WARNING - To reduce the risk of burns, fire, electric shock, or injury to persons, install the treadmill on a flat level surface with access to a 120-volt, 15-amp grounded outlet with only the treadmill plugged into the circuit.

DO NOT USE AN EXTENSION CORD UNLESS IT IS A 14AWG OR BETTER, WITH ONLY ONE OUTLET ON THE END: DO NOT ATTEMPT TO DISABLE THE GROUNDED PLUG BY USING IMPROPER ADAPTERS, OR IN ANY WAY MODIFY THE CORD SET.

A serious shock or fire hazard may result in computer malfunctions. See Grounding Instructions, page 3.

- Do not operate the treadmill on deeply padded, plush or shag carpet. Damage to both carpet and treadmill may result.
- Do not block the rear of the treadmill. Provide a minimum of 3 1/2 feet clearance between the rear of the treadmill and any fixed object.
- Keep children under the age of 13 away from this machine. There are obvious pinch points and other caution areas that can cause harm.
- Keep hands away from all moving parts.
- Never operate the treadmill if it has a damaged cord or plug. If the treadmill is not working properly, call your dealer.
- Keep the cord away from heated surfaces.
- Do not operate where aerosol spray products are being used or where oxygen is being administered. Sparks from the motor may ignite a highly gaseous environment.
- Never drop or insert any object into any openings.
- Do not use outdoors.
- To disconnect, turn all controls to the off position, remove the tether cord, then remove the plug from the outlet.
- Do not attempt to use your treadmill for any purpose other than for the purpose it is intended.
- The pulse sensors are not medical devices. Various factors, including the user's movement, may affect the accuracy of heart rate readings. The pulse sensors are intended only as exercise aids in determining heart rate trends in general.
- Use the handrails provided; they are for your safety.
- Wear proper shoes. High heels, dress shoes, sandals or bare feet are not suitable for use on your treadmill. Quality athletic shoes are recommended to avoid leg fatigue.
- This exercise equipment is not intended for use by persons with reduced physical, sensory or mental capabilities, or lack of experience and knowledge unless they have been given supervision or instruction concerning the use of the exercise equipment by a person responsible for their safety.

Remove the tether cord after use to prevent unauthorized treadmill

operation. SAVE THESE INSTRUCTIONS - THINK SAFETY!

IMPORTANT ELECTRICAL INSTRUCTIONS

WARNING!

Route the power cord away from any moving part of the treadmill including the elevation mechanism and transport wheels.

NEVER remove any cover without first disconnecting the AC power.

If voltage varies by ten percent (10%) or more, the performance of your treadmill may be affected. Such conditions are not covered under your warranty. If you suspect the voltage is low, contact your local power company or a licensed electrician for proper testing.

NEVER expose this treadmill to rain or moisture. This product is NOT designed for use outdoors, near a pool or spa, or in any other high-humidity environment. The maximum operating temperature specification is 40 degrees C, and humidity is 95% non-condensing (no water drops forming on surfaces).

Circuit breakers: Avoid AFCI/GFCI circuit breakers if possible. These breakers may trip occasionally during exercise because of the high inrush currents of the treadmill drive electronics and motor. This is an issue that affects all treadmill brands.

New laws in your area may require these breakers. If you do have these breakers and outlets in your home and are experiencing nuisance tripping, you should check if there are any other devices plugged into the same circuit. Some examples of devices that may also cause tripping are fluorescent lights with electronic ballasts, coffee makers, space heaters and hair drier. Optimally the treadmill should be the only device plugged into the circuit.

Our treadmills have surge suppressors built in to help avoid nuisance tripping. We have tested several AFCI/GFCI breakers and outlets with our products. Brands we have tested are: Eaton (Cutler Hammer Series), Leviton (Smart Lock Pro) and Schneider Electric (Canadian Home Series). These breakers do not trip in our testing, when connected to our treadmills, as long as no other devices are plugged into the same circuit.

GROUNDING INSTRUCTIONS

This product must be grounded. If the treadmill should malfunction or break down, grounding provides a path of least resistance for electric current, reducing the risk of electric shock. This product is equipped with a cord having an equipment-grounding plug. The plug must be plugged into an appropriate outlet that is properly installed and grounded by all local codes and ordinances.

DANGER - Improper connection of the equipment-grounding conductor can result in a risk of electric shock. Check with a qualified electrician or serviceman if you are in doubt as to whether the product is properly grounded. Do not modify the plug provided with the product if it will not fit the outlet; have a proper outlet installed by a qualified electrician.

This product is for use on a nominal 120-volt circuit and has a grounding plug that looks like the plug illustrated below. A temporary adapter that looks like the adapter illustrated below may be used to connect this plug to a 2-pole receptacle as shown below if a properly grounded outlet is not available. The temporary adapter should be used only until a properly grounded outlet, (shown below) can be installed by a qualified electrician. The green-coloured rigid ear-

lug, or the like, extending from the adapter, must be connected to a permanent ground such as a properly grounded outlet box cover. Whenever the adapter is used, it must be held in place by a metal screw.

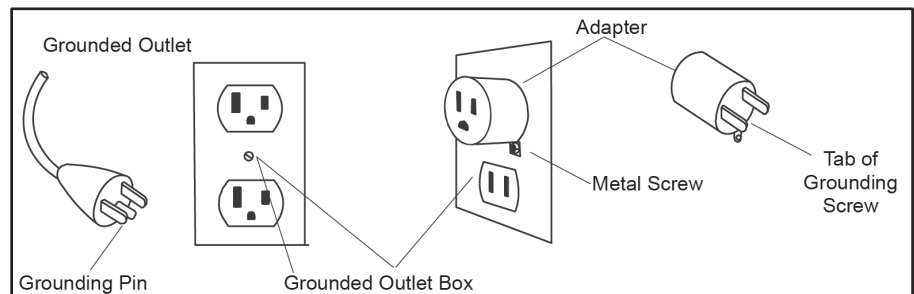

IMPORTANT OPERATION INSTRUCTIONS

- **NEVER** operate this treadmill without reading and completely understanding the results of any operational change you request from the computer.
- Understand that changes in speed and incline do not occur immediately. Set your desired speed on the computer console and release the adjustment key. The computer will obey the command gradually.
- **NEVER** use your treadmill during an electrical storm. Surges may occur in your household power supply that could damage treadmill components. Unplug the treadmill during an electrical storm as a precaution.
- Use caution while participating in other activities while walking on your treadmill; such as watching television, reading, etc. These distractions may cause you to lose balance or stray from walking in the center of the belt; which may result in serious injury.
- **NEVER** mount or dismount the treadmill while the belt is moving. **SOLE** treadmills start at a very low speed, and it is unnecessary to straddle the belt during start-up. Simply standing on the belt during slow acceleration is proper after you have learned to operate the unit.
- Always hold on to a handrail or hand bar while making control changes (incline, speed, etc.).
- Do not use excessive pressure on the console control keys. They are precision set to function properly with little finger pressure. Pushing harder is not going to make the unit go faster or slower. If you feel the buttons are not functioning properly with normal pressure contact your **SOLE** dealer.

IMPORTANT SAFETY INSTRUCTIONS

A safety tether cord is provided with this unit and should be used at all times. It is for your safety should you fall or move too far back on the tread-belt. Pulling this safety tether cord will stop tread-belt movement.

To Use:

1. Place the safety key into position on the console control head. Your treadmill will not start and operate without this. Removing the safety key also secures the treadmill from unauthorized use.
2. Fasten the plastic clip onto your clothing securely to assure good holding power.
Note: *The clip should be attached securely to make certain it does not come off. Be familiar with its function and limitations. The treadmill will stop, depending on speed, with a one to two-step coast anytime the safety key is pulled off the console. Use the red **Stop** switch in normal operation.*
3. If the console displays "Safety key removed, the machine stopped, click Replace the key to Operate", and put the Safety key back to continue using the treadmill.

ST90 ASSEMBLY PACK CHECKLIST

1 HARDWARE STEP 1

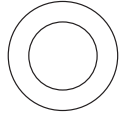

#120. $\text{Ø}3/8" \times 16 \times 1.5\text{T}$
Flat Washer (8 pcs)

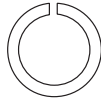

#121. $\text{Ø}10 \times 1.5\text{T}$
Split Washer (8 pcs)

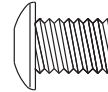

#122. $\text{M}10 \times \text{P}1.5 \times 15\text{L}$
Button Head Socket Bolt (8 pcs)

2 HARDWARE STEP 2

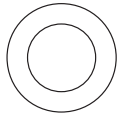

#120. $\text{Ø}3/8" \times 16 \times 1.5\text{T}$
Flat Washer (4 pcs)

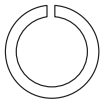

#121. $\text{Ø}10 \times 1.5\text{T}$
Split Washer (4 pcs)



#123. $3/8" \times 1/2"$ _Button Head
Socket Bolt (4 pcs)

3 HARDWARE STEP 3

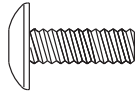

#125. $\text{M}5 \times 15\text{mm}$
Phillips Head Screw (4 pcs)

4 HARDWARE STEP 4

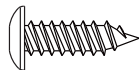

#126. $3.5 \times 16\text{mm}$ _Sheet
Metal Screw (4 pcs)

ASSEMBLY TOOLS

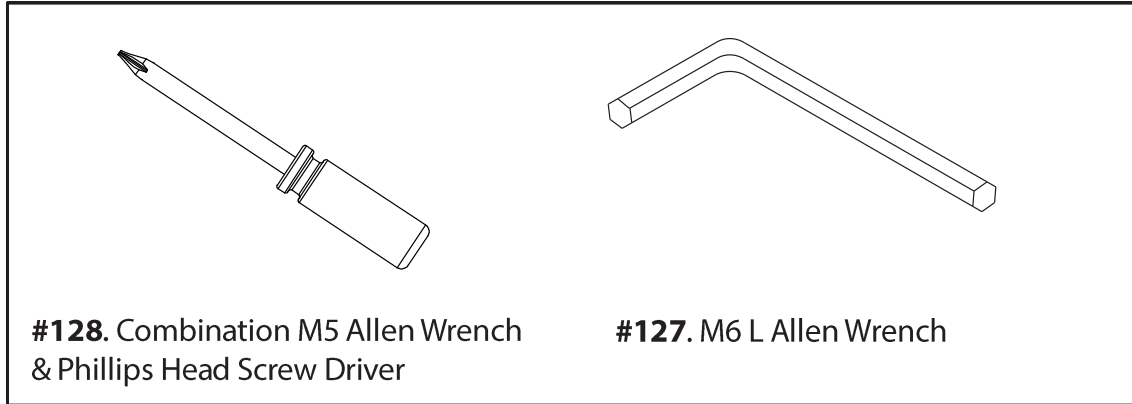

ST90 ASSEMBLY INSTRUCTIONS

1

ASSEMBLY STEP 1

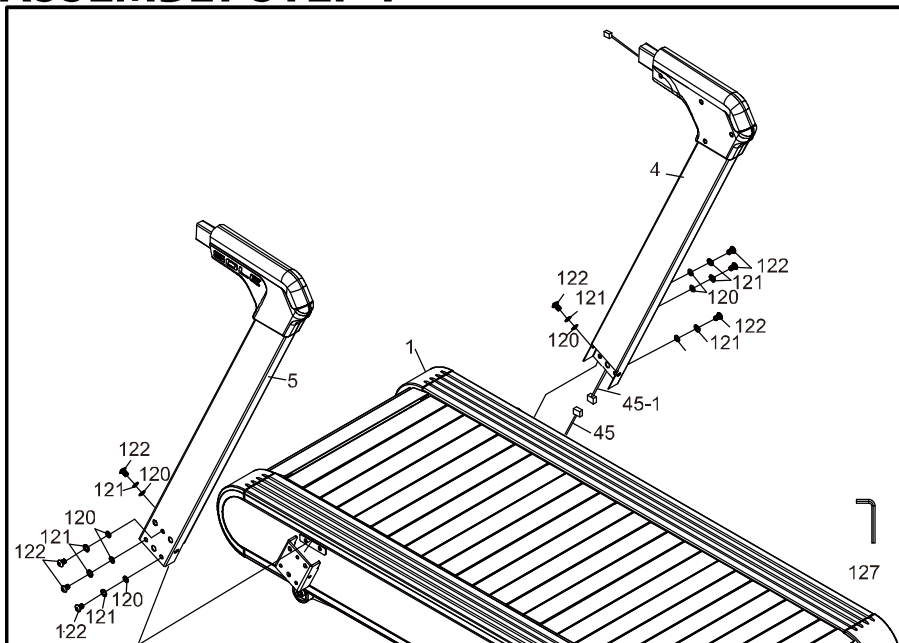

HARDWARE STEP 1

- #120. $\text{Ø}3/8" \times 16 \times 1.5T$ Flat Washer (8 pcs)
- #121. $\text{Ø}10 \times 1.5T$ Split Washer (8 pcs)
- #122. $M10 \times P1.5 \times 15L$ Button Head Socket Bolt (8 pcs)

1. Place Left Upright (5) & Right Upright (4) on Main Frame, Connect the Computer Cable (45-1) of Right Upright (4) with the Computer Cable (45) of Main Frame (1), Secure with eight Button Head Socket Bolt (122) through eight Split Washer (121) -> eight Flat Washer (120) on Main Frame (1) with the L Allen Wrench (127)

2 ASSEMBLY STEP 2

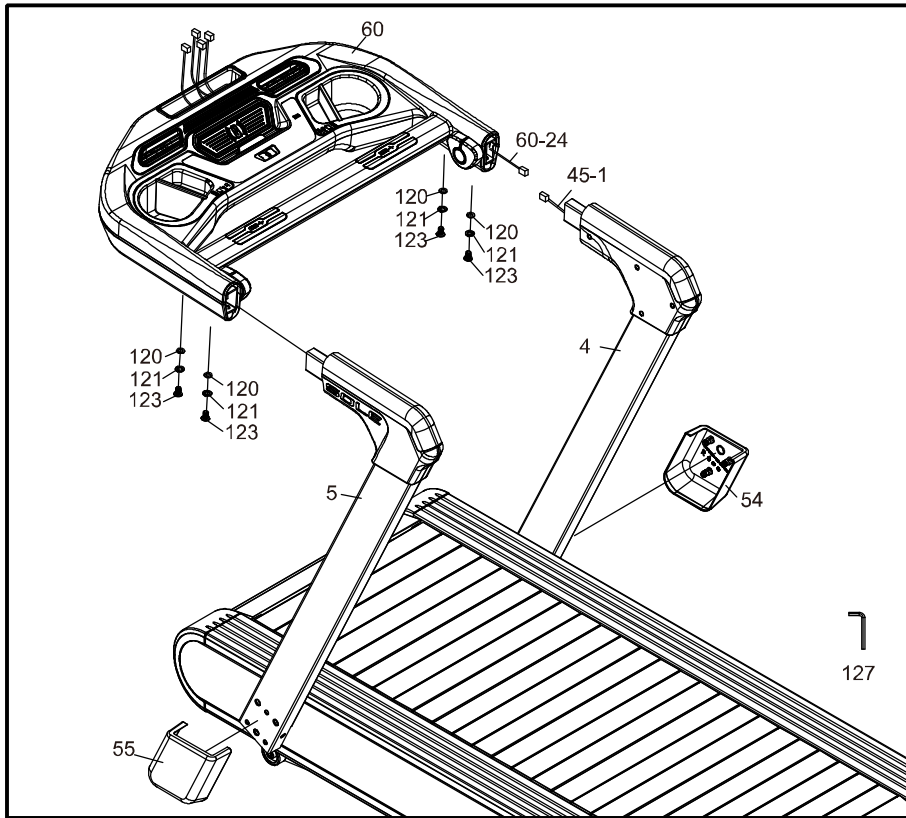

HARDWARE STEP 2

- #120. $\varnothing 3/8" \times 16 \times 1.5T$ Flat Washer (4 pcs)
- #121. $\varnothing 10 \times 1.5T$ Split Washer (4 pcs)
- #123. $3/8" \times 1/2"$ Button Head Socket Bolt (4 pcs)

1. Connect the Computer Cable(45-1) of Right Upright (4) with the Computer Cable (Upper) (60-24) of Console Assembly(Bottom) (60).
2. Install Console Assembly(Bottom) (60) on Right Upright(4) and Left Upright(5) , secure with four Button Head Socket Bolt (123) through four Split Washer (121) -> four Flat Washer (120) by L Allen Wrench(127). Then tighten the bolts of STEP 1 and install Upright Cover(L&R) (55&54) on Upright(L&R) (5&4).

3 ASSEMBLY STEP 3

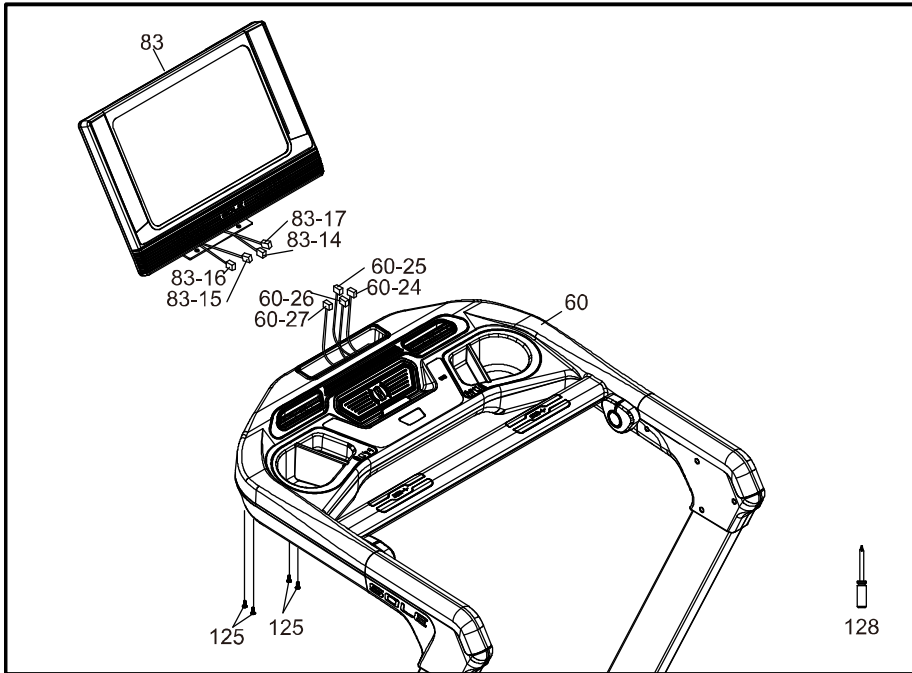

HARDWARE STEP 3

#125. M5 × 15mm
Phillips Head Screw
(4 pcs)

1. To connect Computer Cable (Upper) (**60-24**) & Computer Cable(Upper) (**60-25**) & Computer Cable (**60-26**) & Computer Cable(Lower) (**60-27**) of Console Assembly(Bottom) (**60**) with Computer Cable (**83-17**) & Computer Cable (**83-14**) & Computer Cable (**83-15**) & Handpulse Wire (**83-16**) of Console Assembly(Top) (**83**).
2. Place Console Assembly(Top) (**83**) on Console Assembly(Bottom) (**60**), and secure with four Phillips Head Screws (**125**) with the Phillips Head Screwdriver (**128**).

4

ASSEMBLY STEP 4

HARDWARE STEP 4

#126. 3.5 × 16mm_
Sheet Metal Screw (4 pcs)

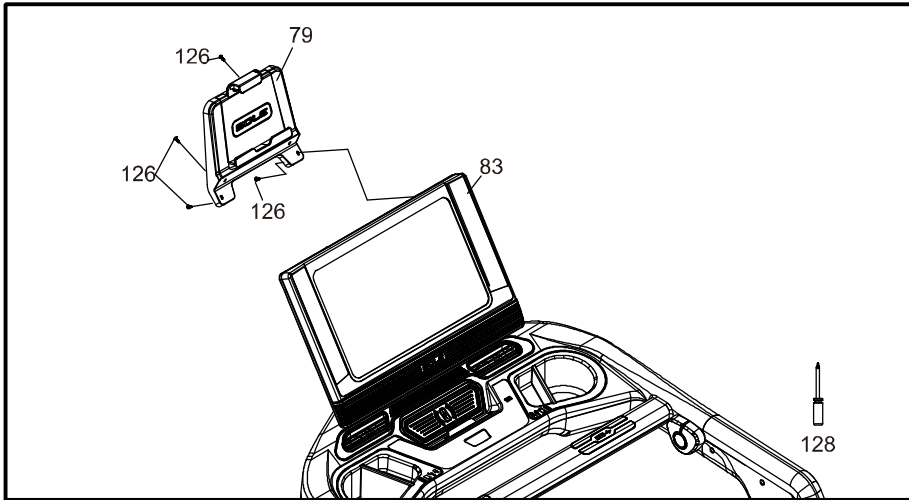

1. Place the PAD holder on Console Assembly(83), and secure with four Sheet Metal Screw (126) with the Phillips Head Screw Driver (128).

OPERATION OF YOUR TREADMILL

GETTING FAMILIAR WITH THE CONTROL PANEL

ST90 CONSOLE



GETTING STARTED

ST90 CONSOLES

Power the treadmill on by plugging it into an appropriate wall outlet, then turn on the power switch located at the front of the treadmill. Ensure that the **Safety Key** is installed, as the treadmill will not power on without it.

****ATTENTION****

SLEEP MODE Your console comes in "Sleep mode" with different features by choice:

ON The unit goes energy-saving state after 15 minutes of inactivity.

OFF The console will stay lit while the power is on.

RETAIL The console will run the demo video after 3 minutes of inactivity.

On TFT displays, click "Sleep Mode" under Settings to switch between three features.

Starting the operation

- Plug in the power cord and switch on the main power switch located at the right, front of the treadmill and make sure that the safety key is put on as the treadmill is unable to operate without the safety key.
- When the power is turned on, the screen will show the initial image and then enter the ready mode which is the beginning of the treadmill operation.

Heart rate feature

The pulse (heart rate) on the screen shows the current value of heartbeats per minute. You must hold both left and right stainless steel sensors to measure the pulse. The pulse value will be shown on the screen continuously. You can also use hand pulse sensors for heart rate control. The console can also detect the pulse from a heart rate chest strap transmitter.

No user detected:

The machine will pause automatically if no user is detected for 10 seconds. When the treadmill is operating with a speed higher than 2 miles/hr (3km/hr), protecting mechanism will be activated. The Pop-up window will ask the user whether to stop/resume the workout program. This pop-up window will remain on the screen for 5 minutes. The treadmill will end the workout automatically if no actions were taken within 5 minutes.

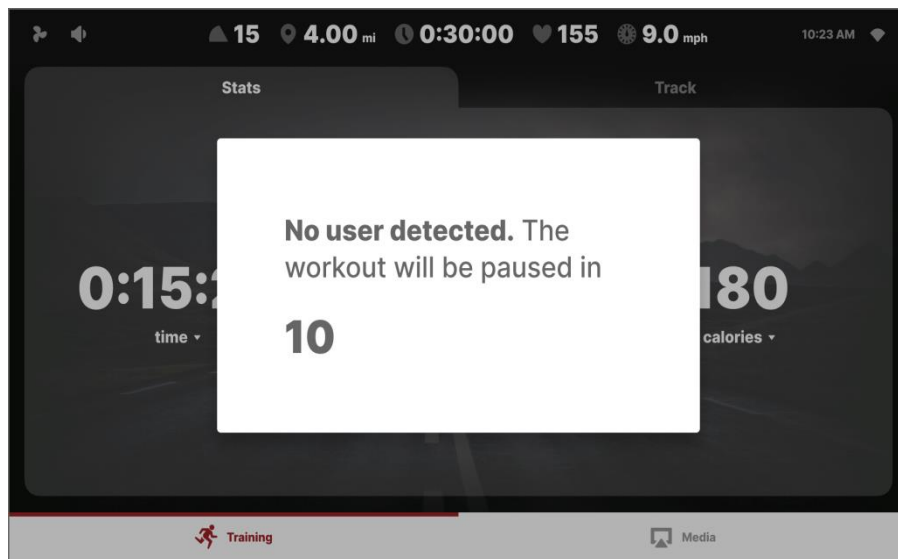

TOUCHSCREEN OPERATION

Use the touchscreen console to select from a variety of preset workout programs and fitness tests, and to enjoy the media content of your choice while on the go.

Getting Started

Launched for the first time, the console will prompt you to either enter as a guest or create a new profile. It is recommended to set up your profile: it allows your machine to remember your physical parameters, favourite programs and templates; you will have your custom program with an adjustable intensity pattern, and your workout records can be synchronized with the SOLE+ mobile app. Tap + to create a new profile. A maximum of 9 profiles can be created. Each profile can be protected with a passcode.

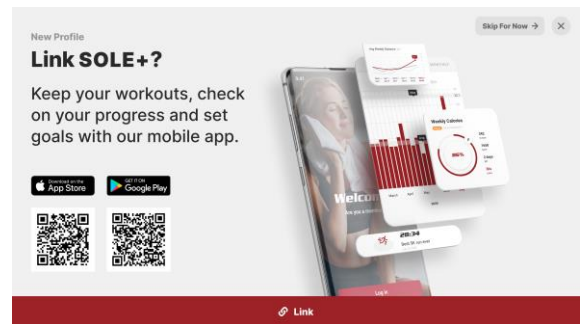
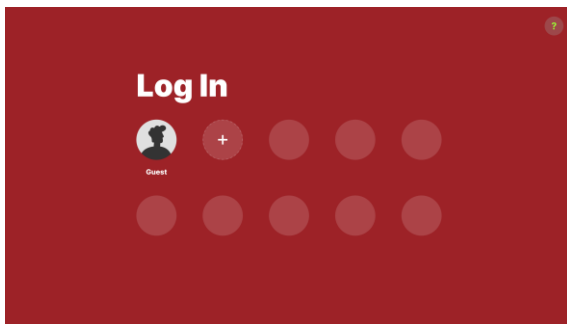

To link a SOLE+ account, scan the QR code on the console screen to download the mobile app first. Once the app is installed and the registration is complete, press “Link” on the bottom of the console screen, then open the QR code scanning camera in your SOLE+ app and scan the QR code once again to link your local profile with the SOLE+ account. Please keep in mind that your console profile cannot be linked to multiple SOLE+ accounts at the same time. If you skip this step, you can access it again later in Profile settings.

Home Screen

The main screen of the Training section displays an overview of your activity and offers shortcuts to the most frequently used training modes: an immediate Start, a manually controlled timed workout (“Timer”), and up to 6 programs that you have marked as your favourites are arranged on this page for your quick access.

If in the Guest mode, you can set your age and weight here; it will help the machine calculate your workout summary more accurately.

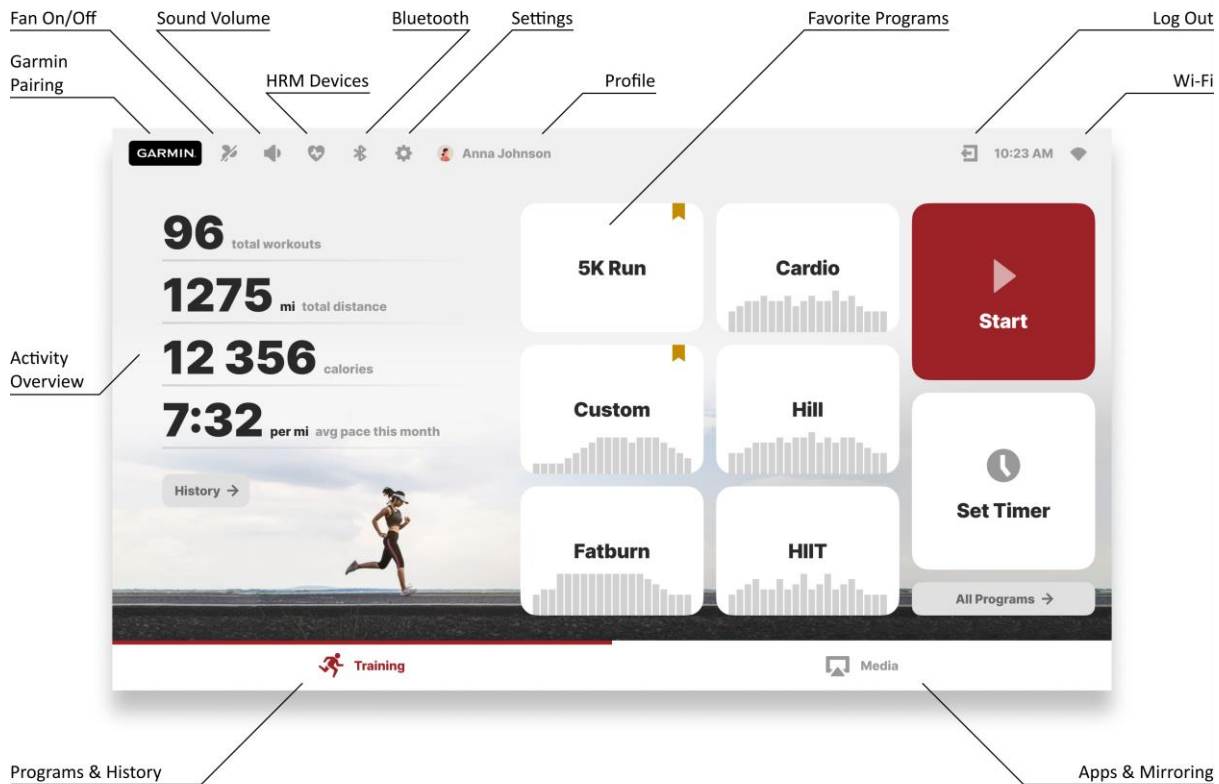

Workout Programs

To access all available categories of programs, press “All Programs” on the Home screen. Once inside, switch between categories using the tabs on the top of the screen: Programs, Fitness Tests, Templates and Favorites.

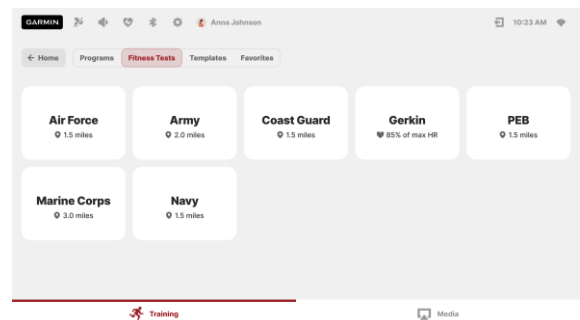
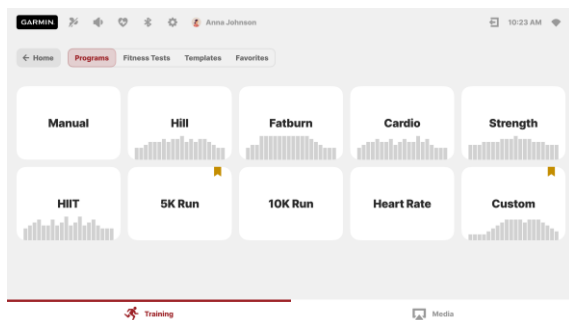

Tap on any of the program cards to open a Program Setup page, where you can learn more about the program, set properties of your workout, or keep browsing by pressing the arrow buttons in the upper top right corner of the screen. To adjust workout parameters, you can drag the ruler, tap on the + and – buttons, or tap on the number to open a numpad and input the value directly.

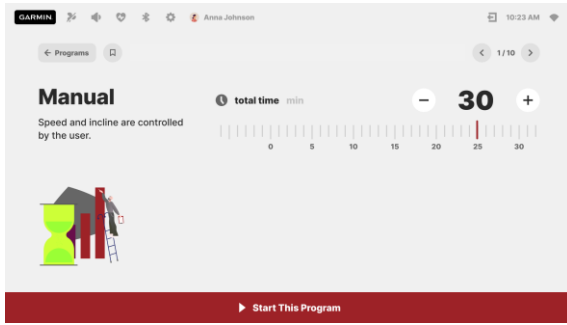

Manual (Timer) program is a timed workout with speed and incline controlled manually at any time during the run.

Hill, Fatburn, Cardio, Strength and **HIIT** follow preset speed and incline changing patterns. The Total Time and Max Speed settings define the duration and overall intensity of your workout.

The speed and incline levels for each segment of the programs are shown in the chart below. Speed values represent a percentage of the max speed that was set before the start. For instance, if the max speed was set to 10.0 mph, and the value in the chart indicates 20, it means that this segment's speed will be 2.0 mph. If the value in the chart indicates 100, this segment's speed will be equal to the max speed you have set before the workout. Incline values are absolute.

Program		Warm-up			1	2	3	4	5	6	7	8	9	10	11	12	13	14	15	16	17	18	19	20	Cool down		
Hill	Speed	40	40	50	66	66	66	66	66	88	88	88	100	100	100	100	100	88	88	88	100	88	66	66	50	40	40
	Incline	0	0	0	0	0	4	8	8	-4	7	7	-5	-5	7	8	9	-4	-4	-5	5	-3	0	0	0	0	0
Fatburn	Speed	40	40	50	75	75	88	88	100	100	100	100	100	100	100	100	100	100	100	88	88	75	75	50	40	40	
	Incline	0	0	0	0	0	4	6	0	0	0	0	6	6	-4	-4	6	0	0	0	0	-3	0	0	0	0	0
Cardio	Speed	40	40	50	66	66	66	75	75	88	88	75	75	88	66	88	75	100	100	88	75	75	66	66	50	40	40
	Incline	0	0	0	0	0	4	4	4	-3	4	4	-2	-2	3	3	3	-2	-2	3	0	0	0	0	0	0	0
Strength	Speed	40	40	50	66	66	66	75	75	75	75	88	88	100	100	100	88	88	88	100	88	75	66	66	50	40	40
	Incline	0	0	0	0	0	4	6	8	10	10	-3	-5	-5	8	8	10	-4	-4	6	8	-5	0	0	0	0	0
HIIT	Speed	40	40	50	75	75	100	50	100	50	100	50	100	50	100	50	100	50	100	50	100	50	100	100	50	40	40
	Incline	0	0	0	0	0	4	0	4	0	4	0	4	0	4	0	4	0	4	0	4	0	0	0	0	0	0

FREE MODE

Running belt is able to move freely under free mode. User may fall if not paying attention. When safety key is pulled, running belt stops immediately. Attach safety key to resume free mode.

1. Select free mode to enter free mode
2. Running belt can move freely under free mode. Please hold on to hand rail and start running.
3. Able to adjust incline up 0~ 8 level.
4. Press stop and the wait for the incline to return to 0 before exiting free mode.

We recommend beginning with the incline set to level 6 to best utilize the gravity-assisted momentum benefits of free mode.

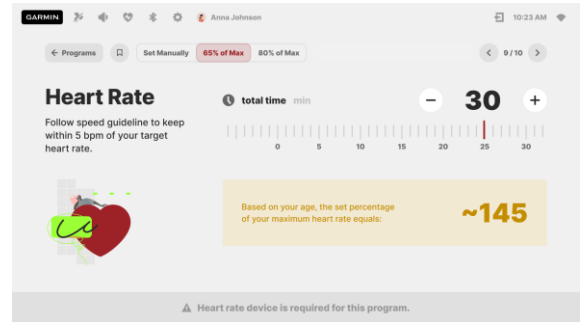
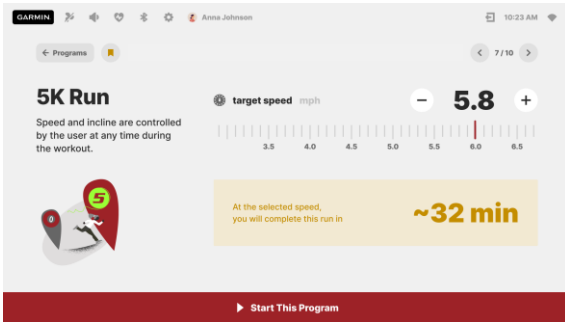

5K Run, 10K Run programs automatically set a target distance for your workout (5 km and 10 km, respectively). On the program setup page, the console will show the estimated total time for this run based on the selected target speed. The program ends when the target distance is reached.

The **heart rate** program uses an incline to control your heart rate. The incline gradually increases until you reach your target heart rate, then adjusts automatically to keep you within 5 bpm of your goal. A heart rate monitor is required for this program.

On the program setup page, you can either set the target bpm directly or select 60% or 80% of your age-predicted maximum heart rate, allowing the machine to calculate your target automatically. Choosing the second option, make sure you have let the machine know how old you are, otherwise, the calculations will be based on the default values. The program is finished when the time is up, or if your heart rate is 20% higher than the target.

Custom is a program with fully customizable speed and incline patterns. On the program setup page, press “Add Pattern” to enter edit mode. Connect dots to map your load throughout the program, from easiest on the bottom to hardest on the top. Each segment’s duration depends on the selected total time — you can set it right before starting.

Speed values are relative, and the maximum can be changed before each workout; all the segments will be adjusted proportionally. Elevation values are absolute and vary from -6 to +15. The elevation pattern is optional.

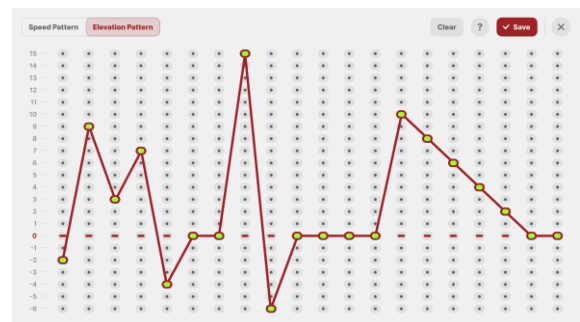
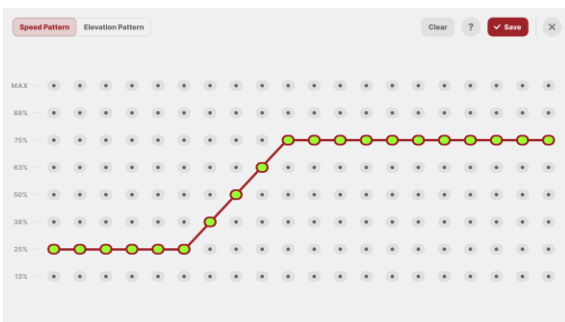

Templates are preset programs with a preserved set of parameters. Programs can be saved as templates upon completion, or you can create one from scratch in the Templates tab: tap on the “New Template” button, choose your base program, then save it with adjusted properties. A maximum of 12 template programs can be stored. To remove the unwanted templates, press “Edit Templates” in the Templates tab.

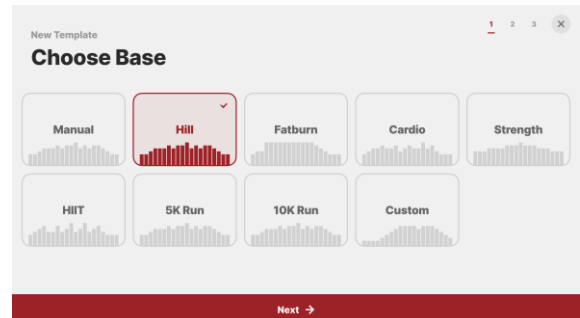
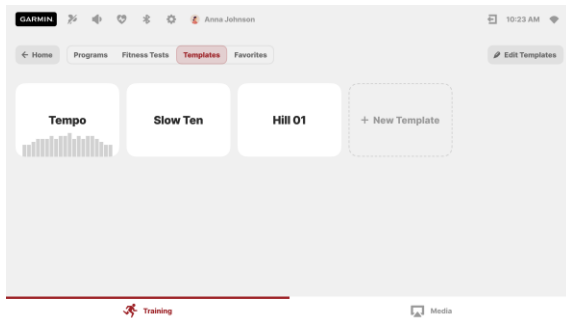

A program can be labelled as a **Favourite**. Up to 6 favourite programs will appear right on the Home screen, so you can access them easier. To “like” a program, open the program setup page and tap on the “ribbon” icon in the upper left corner of the screen. You can find all of the labelled programs under the Favourites tab: to remove the label, press “Edit Favourites”, or go to the program setup page directly and un-tap the “ribbon” icon.

Once you have decided on the program, press the “Start This Program” button on the screen, or the physical “START” key on the machine to begin your workout.

Fitness Tests

Choose from 7 options under the Fitness Tests tab. Tap on the test card to open the test setup page. Please make sure that the physical parameters displayed on this page are correct: this data may affect the course of the test and its results; if the data is not accurate, press “Edit Parameters” to adjust the numbers.

Before the test,

- make sure you are in good health; check with your physician before performing any exercise if you are over the age of 35 or have any pre-existing health conditions;
- make sure you have warmed up and stretched before taking the test;
- do not take in caffeine before the test.

Gerkin Protocol is a sub-maximal VO₂ (volume of oxygen) test, that increases speed and incline alternately until you reach 85% of your max heart rate (a heart rate monitor is required for this test). The time it takes for you to reach 85% determines the test score (VO₂ Max). The test starts with a 3-minute warm-up at a lower speed.

Air Force, Army, Navy, Coast Guard, PEB and **Marine Corps** are US military tests that measure the time required for you to cover a certain distance. The speed is controlled manually.

History

To see your latest workout records, press “History” on the main screen of the Training section. Up to 10 records can be stored locally on the console, but you can access your full workout history if you link your profile to the SOLE+ mobile app. Tap on the record preview to see the full summary. Each user can only see his or her workouts.

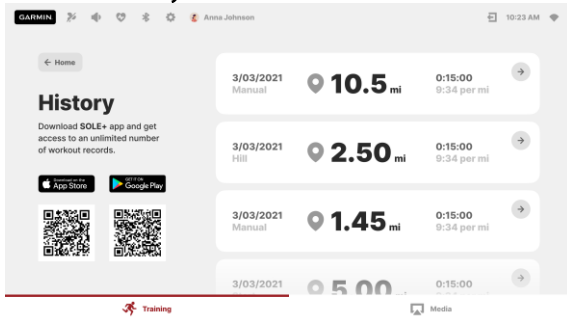

Media

Tap on the right tab of the bottom panel to access the Media section. Choose from a variety of pre-installed third-party **Apps**, or use the **Mirroring** function to cast the content from your smartphone directly to the console screen. For detailed instructions, press the ? icon.

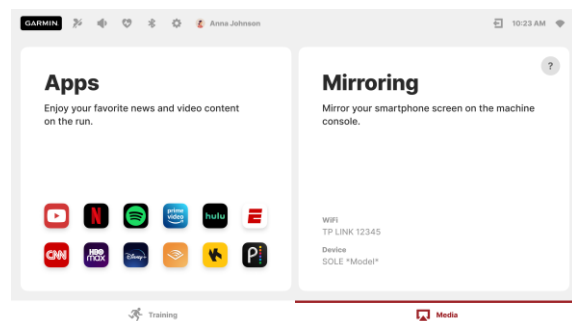

Once the content is on, use the floating panel for navigation and operating full-screen mode. Touch the panel’s top edge and drag the panel around the screen to find the perfect place for it, where it will not prevent you from interacting with the content. Press Hide Panels to enter the full-screen mode without stats on the top and tabs on the bottom, and Show Panels to bring them back. Use the arrow button on the right side of the panel to hide & show the text labels: it allows you to further minimize the panel’s size. Press “Apps” to go back to the content sources selection.

Workout Mode

Once the workout has started, after the short countdown the console will appear in its workout mode. Warm-up and cool-down phases may be skipped by pressing "Skip".

During the workout, switch between **Stats**, **Charts** and **Track** views of the Training section, or go to the Media section to enjoy your favourite media content. In the Stats view, you can select the parameters you would like to display by tapping on the number.

Please use physical keys to adjust speed and incline. Press the physical "STOP" key to pause the workout. Here, you can get back to running, start a cool down, or end your workout and see the summary. After 5 minutes of inactivity in the Pause mode, the workout will end automatically.

The actual machine operation may differ slightly from the description in the manual.

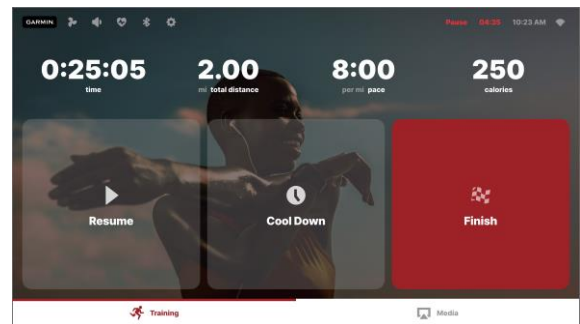
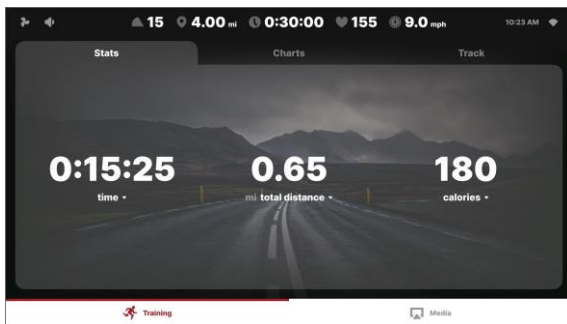

New Sole+ App to be used in conjunction with select Apple & Android devices!

To help you achieve your exercise goals, your new exercise machine comes equipped with a Bluetooth® transceiver that will allow it to interact with selected phones or tablet computers via the Sole + App.

Just download the free Sole + App from the Apple Store or Google Play, and then follow the instructions in the App to sync with your exercise machine.

You can press the "DISPLAY" button from the APP to view the display of the current workout data. When your exercise is complete press the APP "END & SAVE WORKOUT" to store the workout data.

The Sole + App also allows you to sync your workout data with one of many fitness cloud sites we support: Apple Health, Google Fit, Strava, MapMyFitness or Fitbit, with more to come.

Syncing the App with your exercise machine:

1. Download the App by scanning the QR code on the right.
2. Open the App on your device (phone or tablet) and make sure Bluetooth® is enabled on your device (phone or tablet).
3. In the App click the Bluetooth  icon to search for your Sole equipment (shown right).
4. Under the Bluetooth scan result list, select the machine for connection. When the App and equipment are synced, the



Bluetooth® icon on the equipment's console display will light up. Click "DISPLAY", you may now start using your Sole + App.

5. When your exercise is complete press the APP "END & SAVE WORKOUT" to store the workout data, and you will be prompted to sync your data with each available fitness cloud site. Please note you will have to download the applicable compatible fitness App, such as Apple Health, Google Fit, Strava, MapMyFitness or Fitbit, etc, for the icon to be active and available.

Note: Your device will need to be running on a minimum operating system of IOS 13.1 or Android 8.0 for the Sole + App to operate properly.

The exercise equipment can also play music wirelessly via Bluetooth. Turn on your mobile phone or tablet's Bluetooth function. Search for the name "Bt-speaker" in your device's Bluetooth menu. Tap to connect. Now your device can transmit music to the exercise equipment.

The exercise equipment's Bluetooth device (BLE 5.0) can also be connected to the Bluetooth wireless heart rate chest strap transmitter (BLE 5.0). The chest strap transmitter can receive signals even when the App is already in use. You can wear the Bluetooth wireless heart rate chest strap first then commence connection. While in connection, the console will show heart rate value via Bluetooth.



The icon lights up when connecting to a Bluetooth heart rate chest strap successfully and the heart rate will then be displayed. The icon will be off if the Bluetooth heart rate chest strap is disconnected.

Wireless Charging

Wireless Charging function:

Charge your device during your workout by placing it inside the wireless charging box/area properly.

NOTE :

** Your device must be set in the landscape orientation for the best result.

** Your device "charging" icon will indicate it is charging.

*** It provides up to 10 watts of power for many cell phones supporting wireless charging functions.



HEART RATE PROGRAMS

Before we get started, a word about Heart Rate:

The old motto, “no pain, no gain”, is a myth that has been overpowered by the benefits of exercising comfortably. A great deal of this success has been promoted by the use of heart rate monitors. With the proper use of a heart rate monitor, many people find that their usual choice of exercise intensity was either too high or too low and exercise is much more enjoyable by maintaining their heart rate in the desired benefit range.

To determine the benefits range in which you wish to train, you must first determine your Maximum Heart Rate. This can be accomplished by using the following formula: 220 minus your age. This will give you the Maximum Heart Rate (MHR) for someone of your age. To determine the effective heart rate range for specific goals you simply calculate a percentage of your MHR. Your Heart rate training zone is 50% to 90% of your maximum heart rate. 60% of your MHR is the zone that burns fat while 80% is for strengthening the cardiovascular system. This 60% to 80% is the zone to stay in for maximum benefit.

For someone who is 40 years old, their target heart rate zone is calculated:

$$220 - 40 = 180 \text{ (maximum heart rate)}$$

$$180 \times .6 = 108 \text{ beats per minute}$$

(60% of maximum)

$$180 \times .8 = 144 \text{ beats per minute}$$

(80% of maximum)

So, for a 40-year-old the training zone would be 108 to 144 beats per minute.

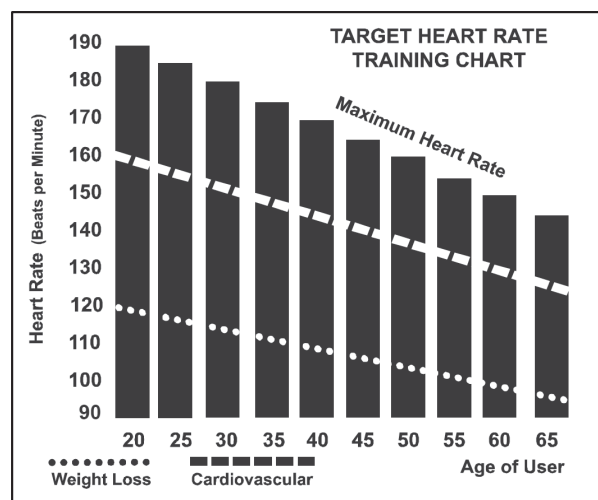

If you enter your age during programming the console will perform this calculation automatically. Entering your age is used for the Heart Rate programs. After calculating your MHR you can decide upon which goal you would like to pursue.

The two most popular reasons for, or goals, of exercise, are cardiovascular fitness (training for the heart and lungs) and weight control. The black columns on the chart above represent the MHR for a person whose age is listed at the bottom of each column. The training heart rate, for either cardiovascular fitness or weight loss, is represented by two different lines that cut diagonally through the chart. A definition of the lines' goal is in the bottom left-hand corner of the chart. If your goal is cardiovascular fitness or if it is weight loss, it can be achieved by training at 80% or 60%, respectively, of your MHR on a schedule approved by your physician. Consult your physician before participating in any exercise program.

RATE OF PERCEIVED EXERTION

Heart rate is important but listening to your body also has a lot of advantages. There are more variables involved in how hard you should work out than just heart rate. Your stress level, physical health, emotional health, temperature, humidity, the time of day, the last time you ate and what you ate, all contribute to the intensity at which you should workout. If you listen to your body, it will tell you all of these things.

The rate of perceived exertion (RPE), also known as the Borg scale, was developed by Swedish physiologist G.A.V. Borg. This scale rates exercise intensity from 6 to 20 depending upon how you feel or the perception of your effort.

The scale is as follows:

Rating Perception of Effort

- 6 Minimal
- 7 Very,very light
- 8 Very,very light +
- 9 Very light
- 10 Very light +
- 11 Fairly light
- 12 Comfortable
- 13 Somewhat hard
- 14 Somewhat hard +
- 15 Hard
- 16 Hard +
- 17 Very hard
- 18 Very hard +
- 19 Very,very hard
- 20 Maximal

You can get an approximate heart rate level for each rating by simply adding a zero to each rating. For example, a rating of 12 will result in an approximate heart rate of 120 beats per minute. Your RPE will vary depending on the factors discussed earlier. That is the major benefit of this type of training. If your body is strong and rested, you will feel strong and your pace will feel easier. When your body is in this condition, you can train harder and the RPE will support this. If you are feeling tired and sluggish, it is because your body needs a break. In this condition, your pace will feel harder. Again, this will show up in your RPE and you will train at the proper level for that day.

USING HEART RATE TRANSMITTER (OPTIONAL)

How to wear your wireless chest strap transmitter:

1. Attach the transmitter to the elastic strap using the locking parts.
2. Adjust the strap as tightly as possible as long as the strap is not too tight to remain comfortable.
3. Position the transmitter centered in the middle of your body facing away from your chest (some people must position the transmitter slightly left of centre). Attach the end of the elastic strap by inserting the round end and, using the locking parts, secure the transmitter and strap around your chest.
4. Position the transmitter immediately below the pectoral muscles.
5. Sweat is the best conductor to measure very minute heartbeat electrical signals.

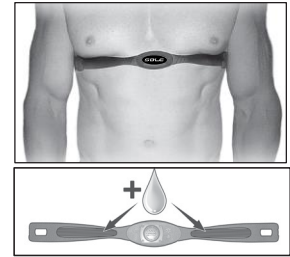

- However, plain water can also be used to pre-wet the electrodes (2 ribbed oval areas on the reverse side of the belt and both sides of the transmitter). It's also recommended that you wear the transmitter strap a few minutes before your workout. Some users, because of body chemistry, have a more difficult time achieving a strong, steady signal at the beginning. After "warming up", this problem lessens. As noted, wearing clothing over the transmitter/strap doesn't affect performance.
6. Your workout must be within range - distance between transmitter/receiver - to achieve a strong steady signal. The length of the range may vary somewhat but generally stay close enough to the console to maintain good, strong, reliable readings. Wearing the transmitter immediately against bare skin assures you of proper operation. If you wish, you may wear the transmitter over a shirt. To do so, moisten the areas of the shirt that the electrodes will rest upon.

Note: The transmitter is automatically activated when it detects activity from the user's heart. Additionally, it automatically deactivates when it does not receive any activity. Although the transmitter is water resistant, moisture can have the effect of creating false signals, so you should take precautions to completely dry the transmitter after use to prolong battery life (estimated transmitter battery life is 2500 hours). The replacement battery is Panasonic CR2032.

ERRATIC OPERATION

Caution! Do not use this treadmill for Heart Rate unless a steady, solid Actual Heart Rate value is being displayed. High, wild, random numbers being displayed indicate a problem.

Areas to look for interference which may cause erratic heart rate:

1. Microwave ovens, TV's, small appliances, etc.
2. Fluorescent lights.
3. Some household security systems.
4. Perimeter fence for a pet.
5. Some people have problems with the transmitter picking up a signal from their skin. If you have problems, try wearing the transmitter upside down. Normally the transmitter will be oriented so the device is right side up.
6. The antenna that picks up your heart rate is very sensitive. If there is an outside noise source, turning the whole machine 90 degrees may de-tune the interference.
7. Loose treadmill console or bolts in the upright tube.
8. Another Individual wearing a transmitter within 3' of your machine's console.

If you continue to experience problems, contact your dealer.

WARNING! - DO NOT USE THE HEART RATE PROGRAM IF YOUR HEART RATE IS NOT REGISTERING PROPERLY ON THE TREADMILL'S DISPLAY!

HEART RATE CONTROL PROGRAM

Heart Rate Control (HRC) uses your treadmill's incline system to control your heart rate. Increases and decreases in elevation affect heart rate much more efficiently than changes in speed alone. The HRC program automatically changes elevation gradually to achieve the programmed target heart rate.

You have the option, during the setup mode, to choose either the HR program. The Weight Control program will attempt to maintain your heart rate at 60% of your Maximum Heart Rate. Your Maximum Heart Rate is based upon a formula that subtracts your age from a constant of 220. Your HR setting is automatically calculated during the setup mode when you enter your age.

SERVICE CHECKLIST - DIAGNOSIS GUIDE

Before contacting your dealer for aid, please review the following information. It may save you both time and expense. This list includes common problems that may not be covered under the treadmill's warranty.

PROBLEM	SOLUTION/CAUSE
The display does not light	<ol style="list-style-type: none"> 1. Tether cord not in position. 2. Circuit breaker on the front grill tripped. Push the circuit breaker in until it locks. 3. Plug is disconnected. Make sure the plug is firmly pushed into the AC household wall outlet. 4. Household circuit breaker may be tripped. 5. Treadmill defect. Contact your SOLE dealer.
Tread-belt does not stay centered Treadmill belt hesitates when walking or running on	Treadmill defect. Contact your SOLE dealer.
The motor is not responsive after pressing Start	<ol style="list-style-type: none"> 1. If the belt moves, but stops after a short time and the display shows "Err", run calibration. 2. If you press Start and the belt never moves, then the display shows "Err", contact service.
The treadmill will only achieve approximately 7 mph but shows a higher speed on display	This indicates motor should be receiving power to operate. Low AC voltage to the treadmill. Do not use an extension cord. If an extension cord is required it should be as short as possible heavy-duty 14 gauge minimum. Low household voltage. Contact an electrician or your SOLE dealer. A minimum of 110-volt current is required.
Tread-belt stops quickly/suddenly when the tether cord is pulled	High belt friction. See General Maintenance.
Treadmill trips on board 15 amp circuit	High belt friction. See General Maintenance.
The computer shuts off when the console is touched (on a cold day) while walking/running	The treadmill may not be grounded. Static electricity is "crashing" the computer. Refer to Grounding Instructions on page 3.
House circuit breaker trips, but not the treadmill circuit breaker	Check that the treadmill is the only equipment in the circuit. See "Important Electrical Information" at the front of this manual for more details.

ERROR MESSAGES

ERROR	MEANING	POSSIBLE CAUSE	
Console showing Error E-01H	Low voltage	Low voltage, please check the outlet. voltage	OK <input type="checkbox"/> NG <input type="checkbox"/>
		Please check the extension cord.	OK <input type="checkbox"/> NG <input type="checkbox"/>
Console showing Error E-02H	Abnormal temperature	Abnormal inverter temperature. Contact your SOLE dealer.	OK <input type="checkbox"/> NG <input type="checkbox"/>
Console showing Error E-04H	Overcurrent	Please check if the motor, drive belt, roller and running belt are stuck.	OK <input type="checkbox"/> NG <input type="checkbox"/>
Console showing Error E-06H	Converter overvoltage	Please check the Braking resistor.	OK <input type="checkbox"/> NG <input type="checkbox"/>
Console showing Error E-07H	Abnormal PFC	Make sure cables are connected securely.	OK <input type="checkbox"/> NG <input type="checkbox"/>
Console showing Error E-08H	GF abnormal	Please check the motor cable	OK <input type="checkbox"/> NG <input type="checkbox"/>
Console showing Error E-09H	Converter overheat	Please clean the cooling fan.	OK <input type="checkbox"/> NG <input type="checkbox"/>
Console showing Error E-0AH	Motor overload	Please check the running belt or check the bearing for damage.	OK <input type="checkbox"/> NG <input type="checkbox"/>
Console showing Error E-0BH	Converter overload	Please check running belt or check the bearing for damage.	OK <input type="checkbox"/> NG <input type="checkbox"/>
Console showing Error E-21H	Abnormal PrEr Flash	Please check running belt or check bearing for damage.	OK <input type="checkbox"/> NG <input type="checkbox"/>
Console showing Error E-22H	EEPROM error	malfunction Contact your SOLE dealer.	OK <input type="checkbox"/> NG <input type="checkbox"/>
Console showing Error E-23H	Low voltage	Low voltage, please check outlet voltage.	OK <input type="checkbox"/> NG <input type="checkbox"/>
		Please check the extension cord.	OK <input type="checkbox"/> NG <input type="checkbox"/>
Console showing Error E-25H	Emergency Stop	The safety key was pulled, please attach the safety key.	OK <input type="checkbox"/> NG <input type="checkbox"/>
Console showing Error E-29H	High-temperature alert	Abnormal temperature, please clean the cooling fan.	OK <input type="checkbox"/> NG <input type="checkbox"/>
Console showing Error E-50H	Communication error	Please check all cables.	OK <input type="checkbox"/> NG <input type="checkbox"/>
Console showing Error E-51H	Inter-communication error	Internal communication error. Contact your SOLE dealer.	OK <input type="checkbox"/> NG <input type="checkbox"/>
Console showing Error E-52H	Incline calibration error	Is the cable between the incline motor and the controller connected correctly and properly?	OK <input type="checkbox"/> NG <input type="checkbox"/>

		Check if the incline mechanism is stock or defective.	OK <input type="checkbox"/> NG <input type="checkbox"/>
		Is VR connected properly or with intermittence?	OK <input type="checkbox"/> NG <input type="checkbox"/>
Console showing Error E-3H	Incline error	Is the cable between the incline motor and controller connected correctly and properly?	OK <input type="checkbox"/> NG <input type="checkbox"/>
		Check if incline mechanism is stock or defective.	OK <input type="checkbox"/> NG <input type="checkbox"/>
		Is VR connected properly or with intermittence?	OK <input type="checkbox"/> NG <input type="checkbox"/>

GENERAL MAINTENANCE

Dirt, dust, and hair can block air inlets and accumulate on the slat belt. Please vacuum your treadmill every month to prevent excess build-up of dirt that can get sucked up, use a soft, damp cloth, or paper towel, and wipe the belt weekly.

UNPLUG THE POWER CORD BEFORE THIS TASK.

EXPLODED VIEW DIAGRAM

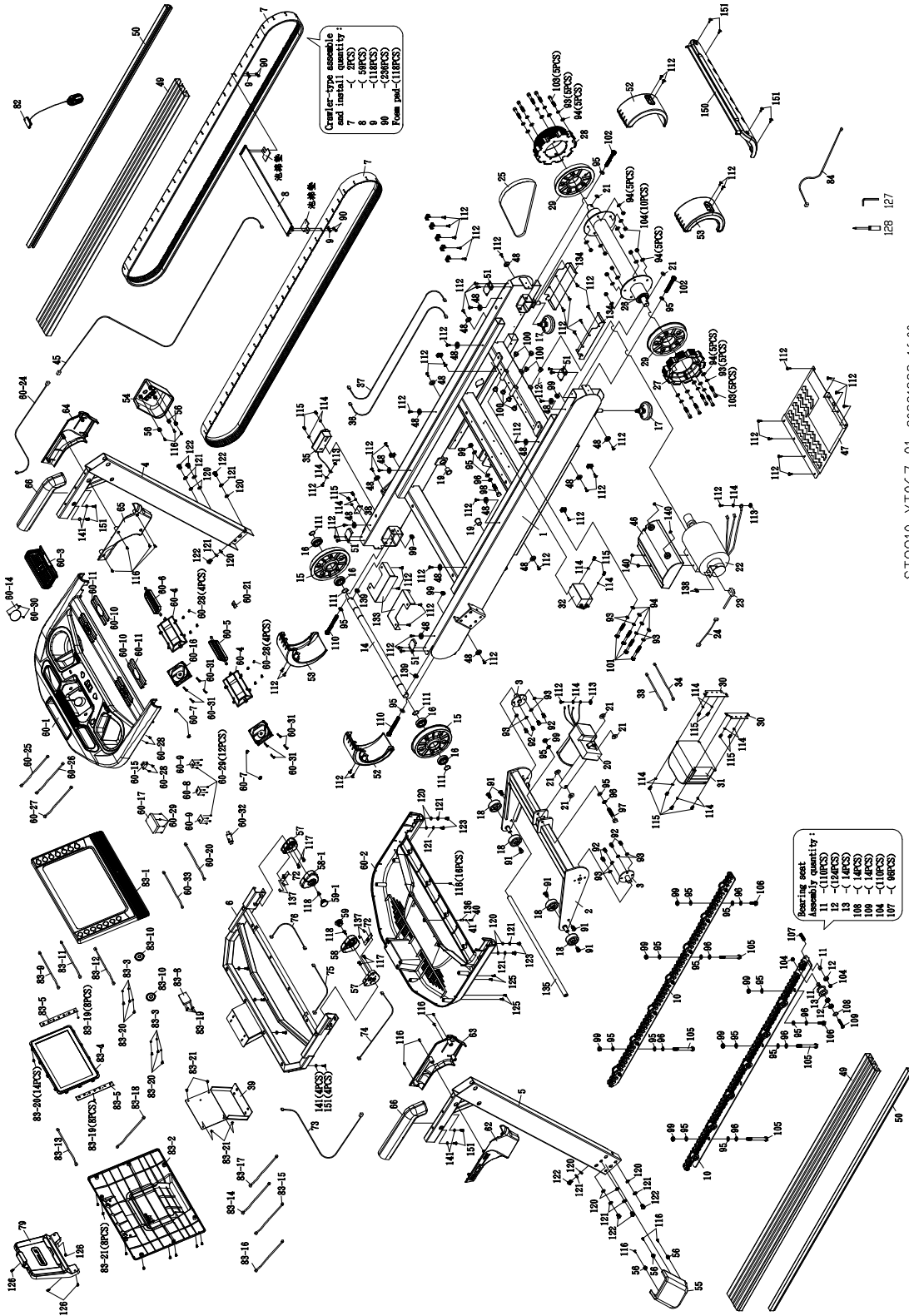

ST8910-YT067-01 20221222 16:00

PARTS LIST

Key	Part Description	Q'ty
1	Main Frame	1
2	Incline Bracket	1
3	Connecting seat Adjustment	2
4	Right Upright	1
5	Left Upright	1
6	Console Support	1
7	Crawler-type	2
8	Pedal	59
9	Fixed washer	118
10	Bearing seat	2
11	Sleeve	110
12	Bearing	124
13	Limit Wheel	14
14	Front axle	1
15	Front roulette wheel	2
16	6005_Bearing	4
17	Foot Pad	2
18	Transportation Wheel	4
19	Foot Pad	2
20	Incline Motor	1
21	Ø10 × Ø25 × 2.5T_Nylon Washer	6
22	AC Motor	1
23	Light Sensor	1
24	100m/m_Connecting Wire	1
25	Belt	1
26	Roller SET	1
27	Timing Pulleys	1
28	Timing Pulleys	1
29	Rear roulette wheel	2
30	Fixing Plate	2
31	2HP Inverter	1
32	Filter	1
33	450m/m_Connecting Wire(White)	1
34	450m/m_Connecting Wire (Black)	1
35	AC Electronic Module	1
36	1350m/m_Connecting Wire(White)	1
37	1350m/m_Connecting Wire (Black)	1
38	Fixed Plate	1
39	Front Bracket Assembly	1
40	3.5 × 32mm_Sheet Metal Screw	1
41	Ø5 × Ø15 × 1.0T_Flat Washer	1

Key	Part Description	Q'ty
45	3000m/m_Computer Cable	1
46	Motor Cap	1
47	Frame Cover	1
48	Ø6 × Ø23 × Ø13 × 5.5T × 3T_Nylon Dished	18
49	Foot Rail(Upper)	2
50	Foot Rail(Lower)	2
51	Limit piece	4
52	Front and back cover A	2
53	Front and back cover B	2
54	Upright Cover(R)	1
55	Upright Cover(L)	1
56	End Cap Stopper	6
57	Key Fast Board Inner Cover	2
58	Key Fast Board Outer Cover(INCLINE)	1
58-01	Key Fast Board Outer Cover(SPEED)	1
59	Key Fast Board Outer Cover Cap(INCLINE)	1
59-01	Key Fast Board Outer Cover Cap(SPEED)	1
060	Console Assembly	1
62	Handlebar Cover Outer(L)	1
63	Handlebar Cover Inside(L)	1
64	Handlebar Cover Outer(R)	1
65	Handlebar Cover Inner(R)	1
66	Handlebar Cover (TOP)	2
72	Interface Board	2
73	550m/m_Speed Cable (Blue)	1
74	900m/m_Resistance Connecting Cable(Black)	1
75	900m/m_Handpulse Wire	1
76	900m/m_Handpulse Wire(Red)	1
79	Tablet Holder Assembly	1
82	Trapezoidal Safety Key	1
83	Console Assembly	1
84	Power Cord	1
90	M5 × 5T_Nylon Nut	236
91	3/8" × 3/4" Button Head Socket Bolt	6
92	M8 × 12mm_Hex Head Bolt	8
93	Ø8 × 1.5T_Split Washer	22
94	Ø8.5 × Ø18 × 1.5T_Flat Washer	24
95	Ø3/8" × Ø19 × 1.5T_Flat Washer	20
96	Ø10 × 1.5T_Split Washer	8
97	M10 × P1.5 × 70L_Hex Head Bolt	1
98	M10 × P1.5 × 55L_Hex Head Bolt	1
99	M10 × 8T_Nylon Nut	11
100	Ø10 × Ø14 × 14mm_Bushing	8
101	M8 × P1.25 × 70L_Socket Head Cap Bolt	4

Key	Part Description	Q'ty
102	M10 × 80mm_Socket Head Cap Bolt	2
103	M8 × 50m/m_Socket Head Cap Bolt	10
104	M8 × 7T_Nylon Nut	120
105	M10 × P1.5 × 100L_Hex Head Bolt	4
106	M10 × P1.5 × 25L_Hex Head Bolt	2
107	M8 × 30mm_Hex Head Bolt	96
108	Wire Clamp	14
109	M8 × P1.25 × 40mm_Socket Head Cap Bolt	14
110	M10 × 100mm_Socket Head Cap Bolt	2
111	Ø25_C Ring	4
112	Ø5 × 16mm_Tapping Screw	64
113	M5_Star Washer	3
114	Ø5 × 1.5T_Split Washer	17
115	M5 × 12mm_Phillips Head Screw	14
116	3.5 × 12mm_Sheet Metal Screw	30
117	M5 × 15mm_Phillips Head Screw	4
118	4 × 16mm_Sheet Metal Screw	2
120	Ø3/8" × 16 × 1.5T_Flat Washer	12
121	Ø10 × 1.5T_Split Washer	12
122	M10 × P1.5 × 15L_Button Head Socket Bolt	8
123	3/8" × 1/2" Button Head Socket Bolt	4
125	M5 × 15mm_Phillips Head Screw	4
126	3.5 × 16mm_Sheet Metal Screw	4
127	L Allen Wrench	1
128	Phillips Head Screw Driver	1
133	Baffle	2
134	Motor Fender	2
135	Incline Limit stopper	1
136	Safety Key Sleeve	1
137	Foam One-sided Glue	4
138	3 × 8mm_Sheet Metal Screw	2
139	M10 × 8T_Nut	2
140	M5 × 6mm_Phillips Head Screw	4
141	Ø5 × Ø13 × 2T_Flat Washer	8
150	Rear Shroud (Middle)	1
151	5 × 16mm_Tapping Screw	12

MANUFACTURER'S LIMITED WARRANTY

TREADMILL WARRANTY

Dyaco Canada Inc. warrants all its Sole treadmills' parts, for a period listed below, from the date of retail sale, as determined by the sale receipt. Dyaco Canada Inc.'s responsibilities include providing new or remanufactured parts, at Dyaco Canada Inc.'s option, and technical support to our independent dealers and servicing organizations. In the absence of a dealer or service organization, these warranties will be administered by Dyaco Canada Inc. directly to a consumer. The warranty period applies to the following components:

Frame Weldments	5 years
Drive Motor	5 years
Deck	3 years
Electronics	3 years
Parts	1 Year
Labour	1 Year
Cosmetic Items *	90 days

*Cosmetic items including, but not limited to the following: grips, console overlays, and labels/decals.

NORMAL RESPONSIBILITIES OF THE CONSUMER

This warranty applies only to products in ordinary household use, and the consumer is responsible for the items listed below:

1. The warranty registration can be completed online: Go to www.dyaco.ca/warranty and complete the online warranty registration.
2. Proper use of the treadmill by the instructions provided in this manual, including belt tracking.
3. Proper installation by instructions provided with the treadmill and with all local electric codes.
4. Proper connection to a grounded power supply of sufficient voltage, replacement of blown fuses, repair of loose connections or defects in house wiring.
5. Expenses for making the treadmill accessible for servicing, including any item that was not part of the treadmill at the time it was shipped from the factory.
6. Damages to the treadmill finish during shipping, installation or following installation.
7. Routine maintenance of this unit as specified in this manual.

EXCLUSIONS

This warranty does not cover the following:

1. CONSEQUENTIAL, COLLATERAL, OR INCIDENTAL DAMAGES SUCH AS PROPERTY DAMAGE AND INCIDENTAL EXPENSES RESULTING FROM ANY BREACH OF THIS WRITTEN OR ANY IMPLIED WARRANTY.

Note: Some areas do not allow the exclusion or limitation of incidental or consequential damages, so this limitation or exclusion may not apply to you.

2. Service call reimbursement to the consumer. Service call reimbursement to the dealer that does not involve malfunction or defects in workmanship or material, for units that are beyond the warranty period, for units that are beyond the service call reimbursement period, for treadmill not requiring component replacement, or treadmill not in ordinary household use.
3. Damages caused by services performed by persons other than authorized Dyaco Canada Inc. service companies; use of parts other than original Dyaco Canada Inc. parts; or external causes such as corrosion, discoloration of paint or plastic, alterations, modifications, abuse, misuse, accident, improper maintenance, inadequate power supply, or acts of God.
4. Products with original serial numbers that have been removed or altered.
5. Products that have been: sold, transferred, bartered, or given to a third party.
6. Products that do not have a warranty registration on file at Dyaco Canada Inc. Dyaco Canada Inc. reserves the right to request proof of purchase if no warranty record exists for the product.
7. THIS WARRANTY IS EXPRESSLY INSTEAD OF ALL OTHER WARRANTIES EXPRESSED OR IMPLIED, INCLUDING THE WARRANTIES OF MERCHANTABILITY AND/OR FITNESS FOR A PARTICULAR PURPOSE.
8. Product use in any environment other than a residential setting.
9. Warranties outside of Canada may vary. Please contact your local dealer for details.

SERVICE

Keep your bill of sale. The labour period is twelve (12) months from the date on the bill of sale. If service is performed, it is in your best interest to obtain and keep all receipts. This written warranty gives you specific legal rights. You may also have other rights that vary in different areas. Service under this warranty must be obtained by following these steps, in order:

1. Contact your selling authorized SOLE dealer.
2. If you have any questions about your new product or questions about the warranty contact Dyaco Canada Inc. at 1-888-707-1880.
3. If no local service is available, Dyaco Canada Inc. will repair the parts, at Dyaco Canada Inc.'s option, within the warranty period at no charge for parts. All transportation costs, both to our factory and upon return to the owner, are the responsibility of the owner. The owner is responsible for adequate packaging upon return to Dyaco Canada Inc. Dyaco Canada Inc. is not responsible for damages that occur during shipping. Make all freight damage claims with the appropriate freight carrier. DO NOT SHIP ANY UNIT TO OUR FACTORY WITHOUT A RETURN AUTHORIZATION NUMBER. All units arriving without a return authorization number will be refused.
4. For any further information, or to contact our service department by mail, send your correspondence to:

Dyaco Canada Inc.
5955 Don Murie Street
Niagara Falls, ON
L2G 0A9

Product features or specifications as described or illustrated are subject to change without notice. All warranties are made by Dyaco Canada Inc.

dyaco

Please visit us online for information about our other brands and products, manufactured and distributed by Dyaco Canada Inc.

SPIRIT

spiritfitness.ca

XTEERRA

xterrafitness.ca

UFC

dyaco.ca/UFC/UFC-home.html

SOLE
FITNESS

solefitness.ca

EVERLAST

dyaco.ca/products/everlast.html

Johnny G
by SPIRIT

spiritfitness.ca/johnnyg.html

TRINOR
SPORTS

trainorsports.ca

For more information, please contact Dyaco Canada Inc.
T: 1-888-707-1880 | 5955 Don Murie St., Niagara Falls, Ontario L2G 0A9 | sales@dyaco.ca

Dyaco Canada Inc. dyaco.ca

SOLE[™]
FITNESS